

**Southern
Regional
Aquaculture
Center**



October 2005

Species Profile

Queen Conch, *Strombus gigas*

Megan Davis*

The queen conch, *Strombus gigas*, is the largest molluscan gastropod (shell length, SL, of 7 to 9 inches; 18 to 23 cm) of the six conch species found in the shallow seagrass beds of Florida, the Bahamas, Bermuda, the Caribbean Islands, and the northern coasts of Central and South America. The queen conch is found in the territorial waters of at least 36 countries and dependent territories. It is known by various names, such as caracol (Mexico, Honduras, Columbia), carrucho (Puerto Rico), cobo (Cuba), and lambi (Hispaniola, French Antilles).

Many studies have focused on fisheries management, ecology and culture techniques of *S. gigas*. In the mid-1970s, culturists began growing queen conch larvae to the juvenile stage for stock enhancement and for grow-out markets as a way to offset fishing pressure. The same culture techniques have been used to study larval ecology and fisheries oceanography, which contribute to the development of regional fisheries management plans.

Natural history

The adult of this slow-moving mollusc has a heavy shell (5 pounds; 2.3 kg) with spines on each whorl of the spire and a glossy, deep pink, flared aperture (Fig. 1). The orange-yellow mantle, located around the soft body of the conch, secretes the shell. The hardened tip (the operculum) at the end of the single, black-speckled foot propels the conch forward in a "hopping" motion referred to as a strombid leap.



Figure 1. Shell of an adult queen conch, *S. gigas* (7 to 9 inches; 18 to 23 cm SL). (photograph by Tom Smoyer)

This movement is thought to help the conch make a quick escape from predators and also break up its scent trail. The eyes are highly developed and are at the tips of two protruding stalks. At the base of the eye stalks is a long proboscis used for grazing diatoms and detritus from seagrass blades and sand grains.

Adult conch have separate sexes (Fig. 2) and are sexually mature at about 4 years, after the lip has fully flared (Fig. 1). Conch are found at a 1:1 sex ratio in unfished populations. Queen conch form large spawning aggregations. Fertilization is internal. The typical 6- to 8-month egg-laying season is March to October, with most activity occurring from July to September when water temperatures are the warmest (82 to 86 °F; 28 to 30 °C). The female lays an average of nine egg masses per season; each crescent-shaped egg mass contains approximately 400,000 eggs (Fig. 3). The thin, sticky strand of eggs is covered with sand grains to camouflage it from predators during the 3- to 4-day incubation period. After the eggs hatch, the planktotrophic veligers (larvae) drift in the water column for 2 to 8 weeks, depending on phytoplankton concentration, temperature, and the proximity of settlement habitat. When the veligers are

*Harbor Branch Oceanographic Institution, Aquaculture Division, Ft. Pierce, Florida.

morphologically and physiologically ready, they metamorphose into benthic animals in response to trophic cues from their seagrass juvenile habitat.

Most conch nursery grounds are in seagrass meadows less than 20 feet (6 m) deep, where the seagrass density is 56 to 84 *Thalassia* shoots per square foot (600 to 900/m²). Juveniles have also been found in algal flats and on deep banks. The juveniles remain buried for most of their first year. As herbivorous gastropods, juveniles and adults feed on a variety of algae such as the green seaweed *Batophora oerstedii*, or on detritus or diatoms commonly associated with the seagrass *Thalassia testudinum*. During the first couple of years, the juvenile conch grow longer shells (Fig. 4) and remain in the seagrass beds. Juveniles do not have flared lips and are sometimes referred to as rollers. As the flaring lip (Fig. 4) begins to form, the sub-adult conch migrate to deeper water near the reef tract and form spawning aggregations. Queen conch are estimated to have a life span of 25 years. Old conch have thick lips and are often called samba conch (Fig. 4).

Fisheries and regulations

For hundreds of years, queen conch have been harvested as a subsistence food source and the shells used for ship ballast, tribal tools, building materials, jewelry and decoration. Beginning in the 1970s, the queen conch commercial fishery developed in response to the rapid growth of tourism in the Caribbean and the increased international demand for the meat. Dishes such as conch fritters, chowder and salad are specialties on menus throughout the region. Queen conch is considered one of the most important benthic fisheries, second only to spiny lobster.

Conch are typically fished using snorkel gear. Once landed on the boat, the shells are removed and discarded onto shell piles called "middens." The conch meat is about 7 to 8 percent of the total

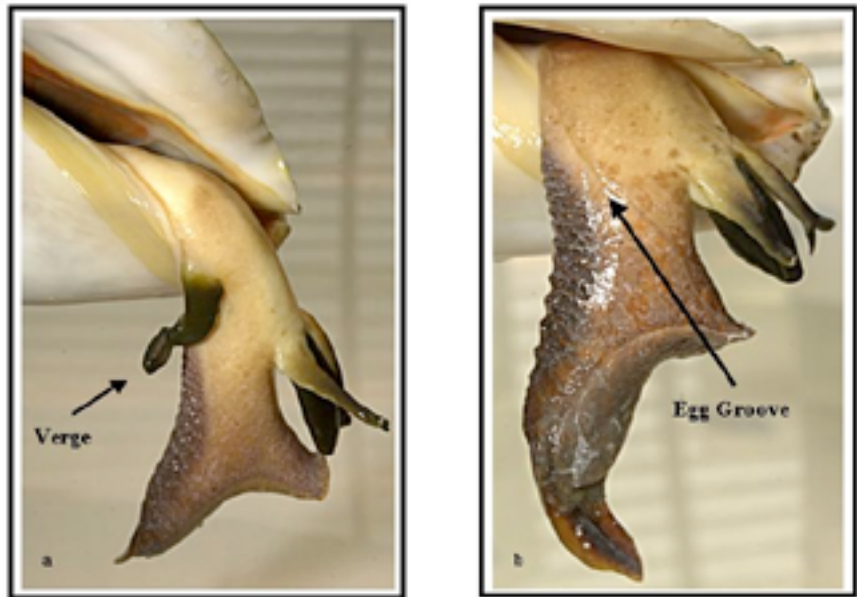

Figure 2. External sex organs of *Strombus costatus* (a) male and (b) female milk conch, which are similar to those of *S. gigas*. (photograph by Tom Smoyer)



Figure 3. Queen conch, *S. gigas*, egg mass. (photograph by LeRoy Creswell)

weight of the animal, ranging from 0.19 to 0.5 pounds (85 to 228 g). The fisherman receives \$1.00 to \$3.00 per conch as a wholesale price. The conch meat is processed to remove the thick skin and the white meat is packaged and frozen in 5-pound (2.3-kg) boxes. Retail prices for conch

range from \$6.00 to \$15.00 per pound and continue to increase as conch stocks become more threatened. Shells, which are a by-product of the meat market, are sold as curios and souvenirs in the U.S., Europe and the Caribbean for \$5.00 to \$20.00 each.



Figure 4. Juvenile and adult *S. gigas* shells from 1 month old to 25 years old. (photograph by Kathy Orr)

The United States is the largest importer of conch from the Caribbean and, in fact, imports approximately 78 percent of the conch meat in the international trade. About 1 million pounds (458,000 kg) was imported in 2004, mostly from the Turks and Caicos Islands (Trade Database: www.cites.org). Imports were as high as 4 to 5 million pounds in 2002 and 2003 when Honduras and Dominican Republic contributed more than 50 percent of the supply to the U.S. In 2003, CITES (Convention for the International Trade of Endangered Species of Wild Fauna and Flora) mandated a temporary closure of the fisheries in these countries until the stocks increase and a sustainable fisheries plan is put into place. This multilateral environmental organization protects and regulates species to ensure that international commercial trade does not threaten their survival in the wild.

The depletion of conch stocks has necessitated management regulations such as total fisheries closures (e.g., in Florida since 1986), annual quotas, size regulations, and the prohibition of scuba diving. While overfishing is the primary cause of the decline, habitat

degradation may also be a factor, especially the loss of important nursery habitats close to shore. In 1992, queen conch was listed in CITES Appendix II and became the first large-scale fisheries product to be regulated by CITES. All conch shipments must be accompanied by a CITES permit stating that the exporting country has determined that the specimens have been legally acquired and that the trade is sustainable.

Some locations, including the Bahamas, Puerto Rico and Florida, have established no-fishing zones or marine protected areas (MPA) to help conserve the queen conch and other ecologically important species. These types of management efforts, along with regional fisheries plans and enforcement, will help this important species recover.

There is considerable interest in the culture of the queen conch to supplement dwindling natural populations. Research began in the 1970s in Los Roques, Venezuela, and in the 1980s several labs in the region made significant contributions to queen conch culture (e.g., University of Puerto Rico, University of Miami, Foundation for PRIDE in

the Turks and Caicos Islands, and USAID in Belize). In 1984, the first commercial conch farm was established in the Turks and Caicos Islands. Today, queen conch laboratories in Mexico (e.g., CINVESTAV-IPN) and Florida (e.g., Florida Fish and Wildlife Conservation Commission, Harbor Branch Oceanographic Institution, and Mote Marine Laboratories) are conducting conch research and education programs.

Culture techniques

Broodstock and egg mass procurement

Hatcheries must gather egg masses from the wild, which can be an unreliable source. Therefore, an enclosed breeding site or "egg farm" is used to ensure a steady supply of wild egg masses for the hatchery. A suitable egg farm site

- is or was traditionally inhabited by adult conch,
- has a calcareous sand and coral rubble substrate with low organic content,
- is located where water movement is less than 1 knot,
- is 4 to 8 m deep, and
- is within 3 km of the hatchery facility, for ease of access and security.

To retain the adult conch, the egg farm is enclosed with a rigid, black polyethylene mesh (2 x 2 inches; 5 x 5 cm) fence 1.6 to 3.3 feet (0.5 to 1.0 m) high. The mesh is held perpendicular to the substrate with reinforcing rods and the ends are attached to moorings, boulders or the land. It is not necessary to remove the fence during the nonbreeding season unless it is in an area where winter storms would damage it.

The egg farm should be stocked annually with sexually mature conch 1 month before the breeding season at a sex ratio of 1:1 and a density of one conch per 100 square feet (one conch/10 m²). Conch are transported to the

egg farm under wet burlap bags and can be held out of the water for 5 hours. Conch should be removed from the egg farm at the end of the breeding season to avoid overgrazing and poor egg production the following season.

It is difficult to differentiate male and female conch from their appearance, although the females are usually larger. Size can be used as a general indication of sex unless fishermen have altered this relationship by preferentially harvesting the larger females. A more accurate, but time-consuming, method of differentiating sexes is to place conch on their sides with their lips pointing up. As they right themselves their sex can be noted: a verge for a male and an egg groove for a female (Fig 2). Another way of determining sex is to observe conch in their mating position

(female in front, male behind) or observe females laying egg masses (Fig. 5).

The crescent-shaped, sand-covered egg mass can be found under the anterior lip of the female conch (Figs. 3 and 5). Egg masses collected directly from underneath the females are hardier and easier to transport because embryo development is minimal. It takes approximately 24 to 36 hours to lay an egg mass, and the eggs hatch in 3 to 5 days. It is not necessary to collect a full egg mass; one-half or three-fourths of an egg mass will yield a substantial hatch. Or, small egg masses can be combined for hatching. For transport to the hatchery, the egg mass is placed in a plastic bag filled with seawater inside a shaded bucket of seawater. Conch egg masses can be shipped within 24 hours to other hatcheries or labo-

ratories by placing each egg mass in seawater in a beverage-sized thermos (0.26-gallon; 1-L).

Researchers are looking for a reliable way to induce egg laying in captivity. In 2000, scientists at the Harbor Branch Oceanographic Institution were the first to observe egg laying in captivity. One female and three male *S. gigas* conch were stocked (one conch per 100 square feet; one conch/10 m²) and held in a circular breeding tank with an elevated sand substrate. The breeding tank was on a recirculating water system and was kept at 81 to 84 °F (27 to 29 °C), 32 ppt salinity, pH 8.0, and ammonia 0.06 to 0.10 mg/L (ppm). The breeding tank was inside a shaded greenhouse and artificial lighting above the tank was set on a 12-hour cycle (8:00 a.m. to 8:00 p.m.). The broodstock were fed approximate-

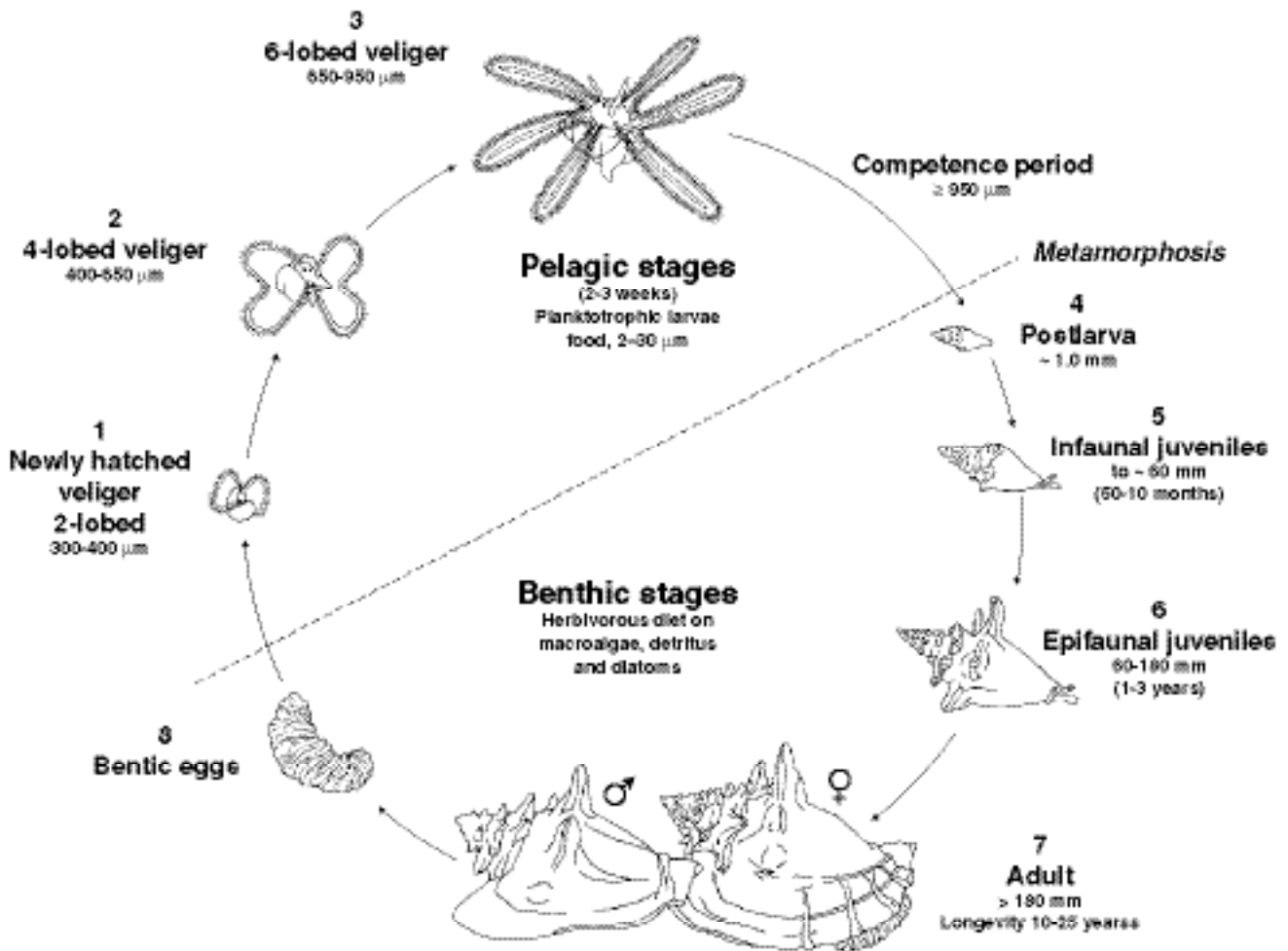

Figure 5. Life cycle stages of the queen conch, *S. gigas*. (drawing by Bonnie Bower-Dennis).

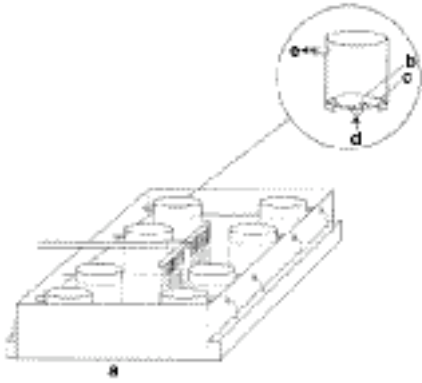

Figure 6. Egg mass incubating containers and tank (a). Each egg mass container holds an individual egg mass (b) on a screen (c). The water upwells through the screen (d) and the water leaves via a small opening in the side of the container (e). (drawing by Jackie Aronson)

ly 50 to 70 g per day of prepared diet—a mixture of koi chow, *Ulva* seaweed, seawater and an alginate binder. Four egg masses were laid by the single female conch in captivity, and the hatched veligers were cultured successfully to the juvenile stage.

Egg mass handling

In the hatchery the egg mass is disinfected to remove bacteria and predators such as polychaete worms, nematodes and crustaceans. The egg mass can be disinfected by dipping it in fresh water for 5 seconds or in a mild chlorine-seawater solution (0.5%) for 30 seconds, then rinsing it in three containers of seawater. The egg mass incubates for 3 to 5 days in an upwelling screen (75 μm) PVC container (6 inches in diameter and 6 inches high; 15 cm x 15 cm) with a flow rate of 0.03 gallons per minute per egg mass (0.1 L/min/egg mass) (Fig. 6). On the day of hatching, the developing embryos steadily rotate and the capsulated veligers have velar lobes that are well-defined with cilia and red pigment on the foot.

Hatchery

If the feeding regime, temperature, stocking density and water quality are optimal, the veliger cycle is approximately 21 days

long (Fig. 5). The emerged veliger is 300 μm SL and has two velar lobes (Fig. 7a), which divide into four by the fifth day (Fig. 7b) and six by the eighth day (Fig. 7c). These lobes continue to elongate until the 0.04-inch (1-mm) SL veliger is ready for metamorpho-

sis (Fig. 7d). The lobes are used for locomotion, respiration and feeding.

Veligers are cultured in 130- to 530-gallon (500- to 2,000-L) conical tanks with gentle aeration (Fig. 8). To keep the veligers in

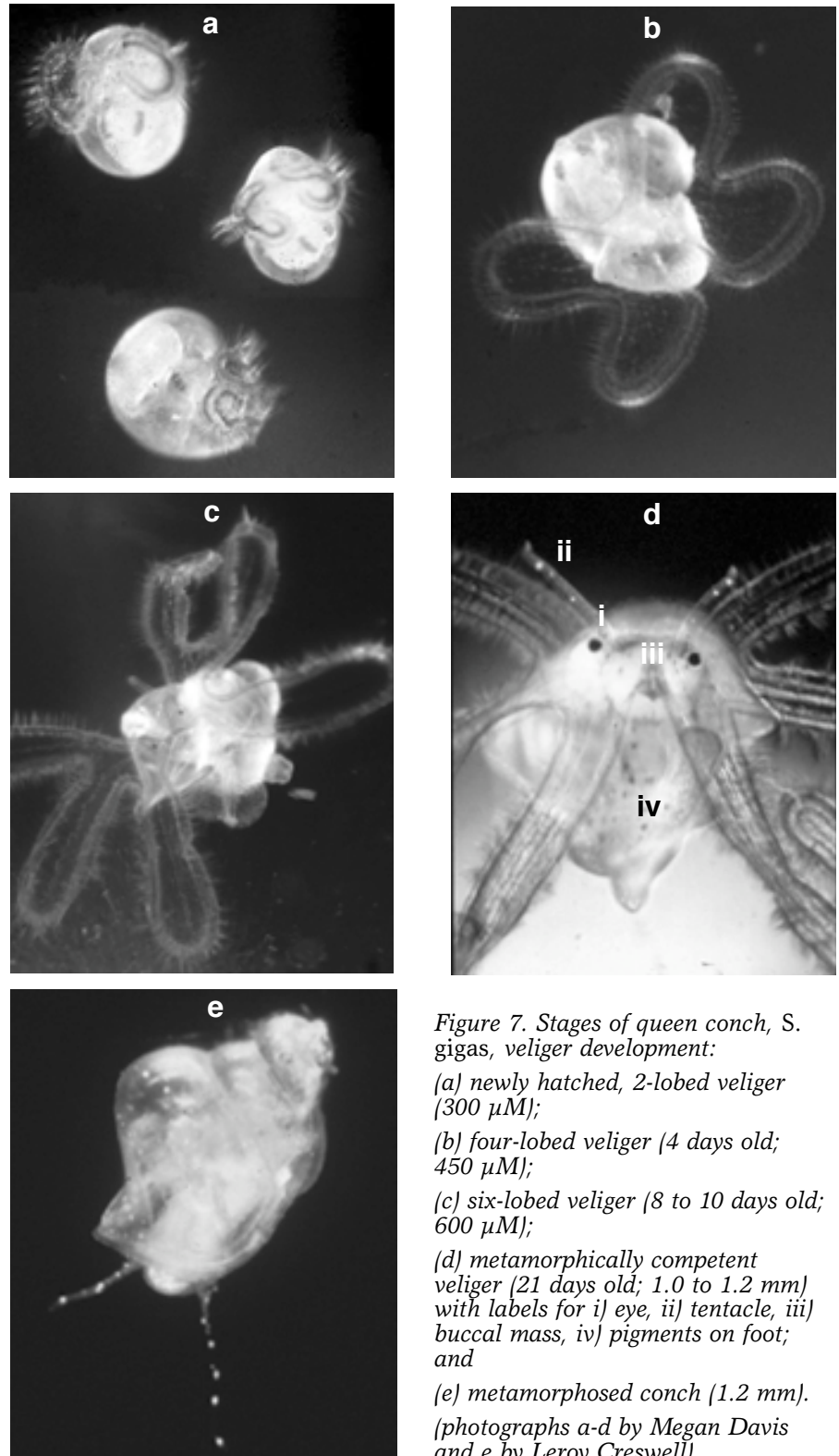

Figure 7. Stages of queen conch, *S. gigas*, veliger development: (a) newly hatched, 2-lobed veliger (300 μM); (b) four-lobed veliger (4 days old; 450 μM); (c) six-lobed veliger (8 to 10 days old; 600 μM); (d) metamorphically competent veliger (21 days old; 1.0 to 1.2 mm) with labels for i) eye, ii) tentacle, iii) buccal mass, iv) pigments on foot; and (e) metamorphosed conch (1.2 mm). (photographs a-d by Megan Davis and e by Leroy Creswell)

suspension, a PVC airlift (6 inches in diameter x 6 inches high; 15 cm x 15 cm) with two air lines (without airstones) attached to either side is positioned 0.2 inches (0.5 cm) from the bottom of the tank (Fig. 8). Conch veligers are large and must be stocked at a relatively low density (560 to 760 per gallon; 150 to 200/L) compared to many bivalve species. Density is gradually reduced during the water changes to a final density of 95 to 150 veligers per gallon (25 to 40 veligers/L) at metamorphosis. Optimal culturing temperature is 82 °F (28 °C) and 36 ppt salinity. However, veligers can be grown at temperatures of 75 to 90 °F (24 to 32 °C) and salinities of 26 to 40 ppt.

Larval cultures are maintained either in a flow-through system (0.3 to 0.6 gallon per minute; 1 to 2 L/min) or in static conditions. Higher densities can be maintained in a flow-through system. Water changes begin the day after hatching and occur every 48 hours. Larvae cannot be dry-sieved; therefore, the PVC sieve (8 inches in diameter x 12 inches high; 20 cm x 30 cm) used for water exchanges is supported in a bucket of seawater (Fig. 7). To help cull the dead and slow-grow-

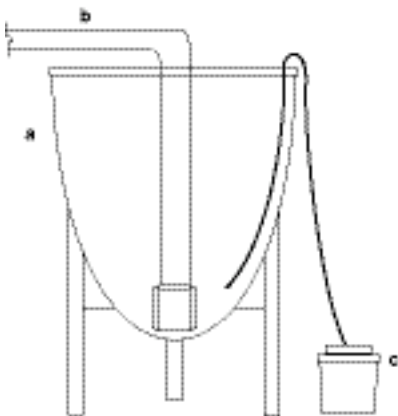

Figure 8. Conical bottom larval tank for culturing queen conch veligers (a). An airlift is positioned at the bottom of the tank (b). Veligers are siphoned from the tank into a sieve suspended in a bucket of water (c). (drawing by Jackie Aronson)

ing veligers, water exchanges start by using a 100- μ m sieve and increase to a 350- μ m sieve toward the end of the larval cycle.

A siphon hose is used to remove the veligers from the tank (Fig. 8). This method is less stressful to the veligers than draining them from the bottom of the tank. After the tank is drained the veligers are gently hosed off the sieve into the newly filled tank. The tank is covered and, in a flow-through system, the water is turned on.

A sample of veligers should be observed daily using a dissecting microscope (20X to 40X) to determine their growth, development, and the amount of feed in the gut. A healthy *S. gigas* veliger has

- a dark gut that fills the top whorls of the shell (indication of feeding);
- clean velar lobes, fully extended, and cilia moving in a wave-like pattern;
- increasing velar lobe and shell whorl development; and
- growth of 50 to 55 μ m SL/day.

A veliger is diseased if it

- is slow to come out of the shell,
- has bacteria and protozoa in the shell or feeding on the veliger's tissue,
- has lobes that are stunted or show necrosis (*Vibrio* bacteria infection),
- moves erratically,
- has debris or protozoa on the outside of the shell,
- has a light gut (lack of food), and
- shows no growth and development.

If there has been a bacterial invasion (e.g., *Vibrio*) during the first 7 days, the veligers will show normal development but all of them will die shortly thereafter. If there is a toxicity problem (e.g., water quality, copper, new PVC pipes and glue, insecticides), the veligers will not develop and

all will die on day four. Stressed veligers will excrete mucus strands that trail behind the swimming larvae and cause them to clump together. This occurs from overfeeding, high density, and rough water changes. The condition is usually temporary and can be solved by decreasing food, lowering density, and improving water exchange methods. A momentary increase in aeration will break the clumps of veligers apart.

Even though veligers hatch with yolk reserves, they will begin feeding on phytoplankton 6 to 8 hours after hatching. Therefore, to increase survival and vigor the veligers should be fed the morning after hatching. Two species of phytoplankton or microalgae are cultured to feed conch veligers—flagellated algae, Tahitian *Isochrysis galbana* or Caicos *Isochrysis*; and the diatom *Chaetoceros gracilis* or *Chaetoceros muelleri*. Batch cultures of phytoplankton are grown in carboys (5-gallon; 20-L) or cylindrical sun tubes (65-gallon; 250-L). The desirable cell concentration of *Isochrysis* in the larval tanks is 1.3×10^6 cells per gallon (5×10^3 cells/mL) for newly hatched veligers and 6.6×10^6 cells per gallon (25×10^3 cells/mL) for metamorphically competent veligers. *Chaetoceros* is added to the culture starting on day 15 and the final concentration in the tank is 0.8×10^6 cells per gallon (3×10^3 cells/mL). In static larval cultures the phytoplankton is added as a batch feed, whereas in flow-through larval tanks the algae cells are diluted with seawater and drip-fed into the culture water for approximately 12 hours.

Metamorphosis

Veligers are metamorphically competent about 21 days after hatch. At this point their shell length is about 0.05 inches (1.2 mm). The veligers are competent when their eyes migrate outward, the tentacles are of equal length, the pigments on the foot change from orange to dark green, the

ctendium (i.e., gills) are elongated and functional, and the buccal mass has developed (Fig. 7d). Several different substances can be used to induce metamorphosis in queen conch larvae, including potassium chloride, hydrogen peroxide, epiphytic diatoms, and red macroalgae. Two of the most reliable inducers for large-scale cultures are extracts from the red macroalgae *Laurencia poitei* and small doses of hydrogen peroxide. At a temperature of 82 to 86 °F (28 to 30 °C), these cues should induce 75 to 95 percent of the conch to metamorphose.

The extract of *L. poitei* is prepared from old, thick, red-brown stalks collected from shallow, sandy, grass flats and transported to shore in mesh bags. The younger stalks, which are yellow-orange, are slightly toxic to veligers and will cause only a small percentage of them to metamorphose. Onshore, the macroalgae fronds are rinsed and sorted to remove coral pieces, sponges and excess sand. Then a ratio of 2 g of *Laurencia* to 1 mL of seawater is blended for approximately 2 minutes in an industrial blender. The solution is frozen for at least 2 days to lyse the cells and release the molecular cues. The frozen solution is thawed overnight, filtered through a 200- μ m polyethylene screen, and the resulting extract refrozen. Four and one-half pounds (10 kg) of collected macroalgae produces 4.2 gallons (16 L) of blended slurry, which yields approximately 2 gallons (7.5 L) of extract.

Before any new *Laurencia* extract is used, the proper dosage is determined by placing 25 competent veligers in three different extract concentrations—7, 10 and 15 mL of *Laurencia* extract/L of seawater—for 4 hours. Then the veligers are removed from the extract and the percentage that has metamorphosed is determined using a dissecting microscope (40X). A veliger has metamorphosed when the velar lobes are lost, it is crawling with its propodium (foot), and it is

searching for food with its proboscis (Fig. 7e). If an extract dosage produces at least 60 percent metamorphosis in the sample, it should be effective on the large-scale.

In recent years, scientists have discovered a more cost-effective procedure for inducing metamorphosis. Competent veligers are exposed to 50 μ M of 3% pharmaceutical grade hydrogen peroxide (0.06 mL of H₂O₂ / 1 L of seawater) for 4 hours. The cost per batch of larvae is about \$0.16, compared to \$15.00 with *Laurencia*. Using hydrogen peroxide reduces the variability found in natural inducers, and it is a simple, low-cost, safe method for commercial-scale induction of metamorphosis.

When a batch of larvae is ready for metamorphosis, a shallow tray (8 feet long x 3 feet wide and as deep as 6 inches; 2.4 m x 0.9 m x 2.4 cm) is filled with seawater and the inducing substance (Fig. 9). The solution is mixed well, then eight shallow screen (250- μ m) trays, each with an area of 430 square inches (2,800 cm²), are placed in the trough. The larvae are stocked at 325 per square foot (3,500 per m²). Veligers should stop swimming 10 to 30 minutes after they are exposed to the metamorphic cue. If they continue to swim, the cue con-

centration should be increased slightly. During the metamorphic process the veligers should be placed in subdued light. After 4 to 5 hours, the system is flushed with water to eliminate the cue.

Newly metamorphosed conch can be kept in a recirculating system or in a flow-through system. Water enters each shallow screen tray through a small tube (0.15 to 0.24 inches in diameter; 4 to 6 mm) (Fig. 9), creating a slight vortex in the downwelling tray. Conch are kept on the screen trays for 14 to 21 days until they reach an average size of 0.12 to 0.14 inches SL (3 to 4 mm SL). The average growth rate is 0.180 mm SL per day or more.

Before conch are fed, the trays are gently shaken to remove wastes and to dislodge the conch crawling on the sides. Newly metamorphosed conch are fed flocculated *Chaetoceros gracilis* for the first 2 to 3 weeks. For large-scale operations, this diatom can be grown in 5,300-gallon (20,000-L) tanks located outside with no cover. For smaller hatcheries, *C. gracilis* can be cultured in 5-gallon (20-L) carboys or in 65-gallon (250-L) cylinders. Chitosan, a macromolecule from the exoskeleton of crustaceans, is used in the flocculation procedure. Chitosan is purchased in a powdered or flaked form.

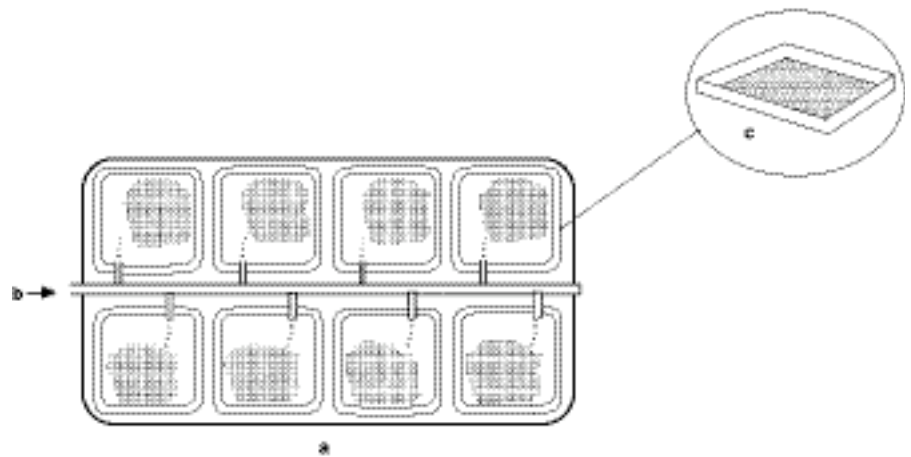

Figure 9. Metamorphosis tank (a) with incoming water (b) and screen trays (c). (drawing by Jackie Aronson)

The flocculating procedure begins by adjusting the microalgae culture to a pH of 6.0 to 7.0 with the addition of muriatic acid (approximately 0.1 to 1.2 mL of muriatic acid/L of algae). The chitosan solution is well mixed into the algae culture at a dose of 5 mL per L of algae. A stock solution of chitosan (10 g chitosan to 1% acetic acid) is prepared in advance and can be stored for several weeks. Sodium hydroxide (5% or 5 g NaOH/100 mL fresh water) is added to raise the pH to 8.5 to 9.0 (approximately 1.0 to 1.5 mL/L of algae). The algal cells are stirred again for several minutes until flocculation is observed. The flocculated cells settle to the bottom of the vessel and can be separated from the "clear" water. If small quantities of flocculated algae are needed on a daily basis, the settled algae can be stored in the refrigerator for up to 1 week. On the first day of metamorphosis, the conch are fed about 6×10^7 cells per conch per day. Feeding increases to 20×10^7 cells per conch per day for conch that are 14 to 21 days old.

Nursery

The post-larval conch (3 to 4 mm SL) are placed in sand troughs 10 feet long x 2 feet wide x 2 feet high (3m x 0.6m x 0.6 m) at 316 conch per square foot (3,400 conch/m²) (Fig. 10). These troughs have an elevated sand substrate made up of crushed coral arago-

nite (1 to 3 mm diameter) and constant water flow and air supply. The water downwells through the sand, is recirculated through a sump and returned to the trough. This system can also be set up as a flow-through system. Depending on the size of the conch, the sand trays are sprayed down every 2 to 4 weeks to remove accumulated waste products. During this process, the sand and the animals are left intact and the conch lie dormant.

Juvenile conch (0.8 to 1.6 inches SL; 2 to 4 cm SL) can be placed in shallow, circular, fiberglass or cement ponds, or lined raceways, at a stocking density of 14 conch per square foot (150 conch/m²). During this nursery stage, the density will need to be reduced to seven conch per square foot (75 conch/m²). Adding sand to the bottom will aid in shell formation and assist with biofiltration. Nursery systems also can be either recirculating or flow-through. Water should enter the conch ponds or raceways from one or two spray bars to create a circular flow that exits through a central standpipe. The optimal flow rate is based on conch density, temperature and feeding strategy. To enhance growth and survival, the nursery ponds or raceways should be covered with 100% shade cloth. Juvenile conch prefer shaded areas because in the wild they are found buried in the sand. The optimum tempera-

ture for rearing juvenile conch is 81 to 84 °F (27 to 29 °C). Growth rates range from 0.180 to 0.250 mm per day and survival rates are as high as 90 to 95 percent.

Conch are fed once a day with either a gel-based diet or a commercial conch chow. The gel feed consists of ground koi or catfish pellets (36 percent), dried *Ulva* sp. seaweed (16 percent), gelatin or alginate (6 percent), and seawater (42 percent). The gelatin or alginate allows the feed to remain stable for approximately 48 hours. The diet can be manufactured in a feed mill or made in smaller quantities using a stove and stainless steel cooking pot. The approximate cost of the processed diet is \$3.20 per pound with catfish pellets and \$4.50 per pound when koi pellets are used. The gel feed has a shelf life of 1 week if refrigerated and several months if frozen.

Juveniles 0.12 to 0.16 inches long (3 to 4 mm SL) are fed approximately 10 mg of feed per conch per day. Larger juveniles (1.2 to 1.6 inches SL; 30 to 40 mm SL) are fed approximately 120 mg of feed per conch per day. Smaller conch are fed about 15 percent of wet-meat weight. As they increase in size (2.4 inches SL; 6 cm SL) they are fed 2 to 7 percent of the wet-meat weight. The typical growth rate on the gel diet is 0.18 to 0.20 mm per day, depending on temperature and stocking density. Conch fed the commercial feed have a feed conversion ratio of 1.5:1 for dry weight of feed to total wet-weight of the conch (shell and meat).

The leading edge of the shell of a healthy juvenile is thin and usually covered with feed, sand and feces. The conch fills the shell, and the foot and operculum are easily seen in the aperture. An undernourished conch recedes into the shell, making it difficult to see the foot and operculum. When a conch is not growing the shell becomes covered with a green or blue-green algae.

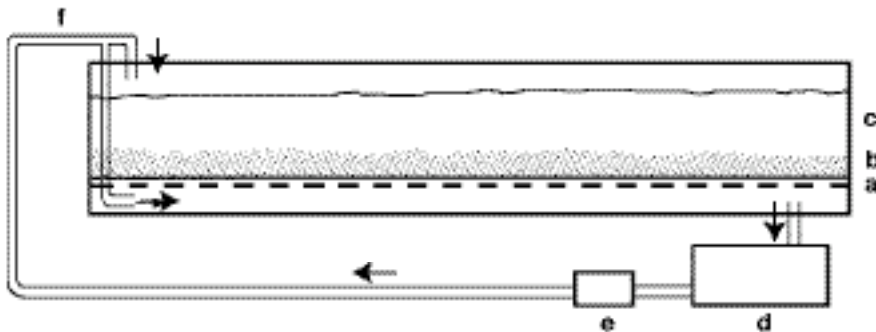

Figure 10. Juvenile trough system with elevated support (a) for sand substrate (b). The water in the tank (c) drains through the sand and into a sump (d); the pump (e) sends the water into the tank and underneath the substrate (f). (drawing by Jackie Aronson)

Conch are most active at night. During the day they lie dormant with their apertures toward the sand substrate and tend to be partially buried when not feeding. When underfed, conch are active during the day searching for food. Juvenile conch in poor health are often observed on the sand surface, positioned with their opercula upward and their bodies partially extending out of their shells. In this state, their response to a stimulus is often sluggish. This behavior could be a result of stagnant water flow (e.g., low oxygen), overfeeding, or stress from handling. Remedies include flushing the tank, feeding less, and/or adjusting the water flow rate. The kicking behavior conch sometimes exhibit is usually a sign of stress and has been observed when the animals are in low-oxygen situations or are fed certain types of artificial feed (e.g., *Spirulina*).

Grow-out

Larger juveniles can be grown from 2.8 to 7 inches SL (7 to 18 cm SL) in a sea pasture with a predator-exclusion fence or in cages. Suspected or known predators of queen conch include brachyuran crabs, hermit crabs, spiny lobster, octopus, fish, sharks, rays, turtles and other carnivorous gastropods. The fence should extend from the bottom to the high-tide line. A variety of fencing or cage material can be used to exclude predators and contain conch. Large, circular cages (80 feet in diameter, 5,400 square feet; 25 m in diameter, 500 m²) with mesh openings (6 to 8 inches in diameter; 15 to 20 cm in diameter) will help to exclude large predators; smaller mesh (2 inches in diameter; 5 cm in diameter) placed along the bottom will exclude smaller predators and help to keep juvenile conch from escaping. Inexpensive traps such as empty adult conch shells can be used to catch octopus; baited traps can collect lobsters and gastropod (*Fasciolaria tulipa* and *Murex ponum*) predators.

The stocking density for juvenile conch should reflect the density found in the wild, which is one to two conch per 10 square feet (one to two/m²) or approximately 4,050 conch per acre (10,000/hectare). Cages can be stocked at a higher density (one conch per square foot; 10/m²) than open sea pasture; however, the natural food supply may need to be supplemented with a prepared diet.

Stock must be rotated through the sea pasture to avoid overgrazing. The best grow-out sites are historical nursery grounds. These sites have a sandy bottom with an intermediate density of sea-grass (56 to 84 *Thalassia* shoots per square foot; 600 to 900/m²) and high algal productivity. They are 7 to 13 feet (2 to 4 m) deep and have strong tidal currents (1 to 2 knots) to flush the area and bring in new feed.

Grow-out from 2.8 to 7 inches SL (7 to 18 cm SL) will take approximately 1.5 to 2 years at a growth rate of 0.15 to 0.20 mm per day. Conch are harvested from the sea pasture by divers working from small boats. They can be processed on-site or sold live to restaurants or wholesalers. Survival in the sea pasture should be 60 to 90 percent, depending on the effectiveness of the cages or fences, the availability of feed, and the success of the predator trapping program.

Stock enhancement

Reintroducing conch in overfished habitats has been suggested as a way of re-establishing conch spawning where the natural population is not likely to recover. To date there have been no large-scale reseeding efforts with queen conch juveniles. However, several stock enhancement studies conducted in Florida (Florida Fish and Wildlife Conservation Commission), the Bahamas (University of Miami, Caribbean Marine Research Center) and Puerto Rico

(University of Puerto Rico) have contributed valuable data about the feasibility of releasing conch juveniles into the wild. (These studies released juveniles less than 4 inches [10 cm] long.) First, release sites should provide the same conditions as grow-out environments. Released animals should be more than 3 inches long (> 7.5 cm SL) and equivalent to wild stocks (e.g., shell morphology, shell strength, burial patterns, predator avoidance). Released conch should be hatched from several egg masses to improve genetic diversity. Planting should be done in the fall and before the full moon to lessen predation, and several thousand conch should be released at one site. Harbor Branch Oceanographic Institution is researching ways to improve husbandry techniques so that juvenile conch from aquaculture facilities will be similar to their wild counterparts. It was determined that conch grown at a high density of 18 to 37 conch per square foot (200 to 400/m²) to 3 inches SL (7.5 cm SL) on aragonite sand had the strongest shells and were able to burrow into the sand.

The success of a conch release program will depend on the cost of seed, the quality of the seed stock, and the participation of the government and the local fishermen. Given the high cost of conch seed (from \$0.20 each for 2-cm seed to \$0.75 for 7- to 9-cm seed) stock enhancement may not yet be economically feasible. However, every conch that survives to adulthood can be measured in terms of its reproductive output rather than as a product for the fisheries. Therefore, releasing juvenile conch and transplanting adult conch to form spawning aggregations may be the ideal way to bring back depleted populations. Grow-out in pastures and pens is the suggested method of producing conch for the fisheries market.

Markets

Queen conch has long been a favorite item on the menus of restaurants in the Caribbean and Florida. The tasty, tender meat is protein-rich (20 percent) and contains no saturated fat. Conch meat has a crunchy texture similar to that of geoduck clams and a taste with the sweetness of abalone. Because the market is based almost entirely on wild-harvested animals, the demand is for legal size conch (3 to 4 years old) with fully formed lips. Retail prices for wild-harvested conch from Jamaica, the Turks and Caicos Islands, Belize and the Bahamas range from \$6.00 to \$15.00 per pound.

New markets have been established for smaller cultured conch, now that large numbers of farmed-raised conch are available on a regular basis from the commercial conch farm in the Turks and Caicos Islands. CITES has approved these farm-raised conch to be sold live in-the-shell or shucked at a sub-legal size (1.2 to 4 inches SL; 3 to 10 cm SL). It is very difficult to locate large numbers of conch smaller than 4 inches SL (< 10 cm SL) in the wild, so there is little concern about exploiting this size juvenile from natural habitats. These hatchery-reared conch are sold live to restaurants in Providenciales, the Turks and Caicos Islands, Florida and New York at a wholesale price of \$0.50 to \$0.75 each. These small conch are served in traditional escargot dishes, bouillabaisse, paelas and gumbos; they also can be served ceviche-style or as tempura, and are boiled or steamed to be served as medallions.

The second market for small conch is the aquarium trade, where the wholesale price to retailers is \$1.75 to \$2.25 each. Conch sold for aquaria are 1.2 inches (3 cm) SL and graze on algae and diatoms from the sand, rocks and glass of the aquaria.

Before live conch are shipped, they are sorted by product type (e.g., food or aquarium market) and purged for 12 to 24 hours (no feed) in flow-through or recirculating

seawater systems. Conch are shipped dry. On the day of shipment, the conch are placed on top of layers of moist paper towels inside plastic bags that are packaged inside insulated boxes. A small amount of oxygen is added to the plastic bags before they are closed. Cold packs keep the conch cool during shipment (72 °F; 22 °C). Conch are shipped by air and will arrive with 100 percent survival if shipment time is less than 36 hours.

Some restaurants prefer to buy small conch shucked or removed from the shell. A specialized shucking tool is used to release the conch muscle from the columella. The guts are removed and the conch are packaged in 1-pound bags for shipment. There are approximately 96 conch per pound at 2.4 inches (6 cm) SL and 43 conch per pound at 4 inches (10 cm) SL. Bags of conch are refrigerated or frozen and packaged in coolers for shipment.

Farm-raised conch have been well received by chefs and their clients. Several chefs have stated that farm-raised conch is sweeter and more tender than wild conch. The tenderness appears to be related to their small size and the fact that they are sold live or fresh, whereas most wild conch are larger and sold frozen.

Economics

Now that queen conch are being cultured successfully and wild stocks have dwindled below sustainable levels in several countries, private and government groups from Caribbean countries have expressed interest in setting up hatcheries for seed production, stock enhancement and commercial grow-out.

To be economically successful, a commercial queen conch farm needs to produce at least 500,000 juvenile conch per year either to supply the specialty markets for small conch or to stock into grow-out pastures. If the farm sells 500,000 small conch (2.4 to 4 inches SL; 6 to 10 cm SL) to the food markets, the gross yearly revenue would be about \$375,000 (\$0.75 each for 4-inch SL conch). It is esti-

mated that another 3,000 or so conch per month could be sold to the wholesale aquarium market at \$0.75 each, for an additional yearly gross revenue of \$27,000. The main advantages of selling smaller conch are that the product is ready for market in 6 to 12 months and there is no need for the sea pasture.

Another market for conch is other nursery and grow-out farms. The estimated value of conch seed is \$0.01 per mm of shell length, or \$0.10 for 0.4-inch SL (1-cm SL) conch and \$0.70 for 3-inch SL (7-cm SL) conch. There is an ever-increasing need for countries to have centralized hatcheries that can supply nursery and grow-out farms with seed conch.

If a farmer planned to harvest 500,000 legal-size conch per year from sea pasture cages, the farmer would have to stock 50 acres (20 hectares) of sea pasture at 1 conch per square foot (10 conch/m²) and allow for crop rotation. Because the grow-out time is 1.5 to 2 years, the farmer should have two crops in the sea pasture at the same time. Therefore, a total of 100 acres (40 hectares) are needed. If optimal survival is 90 percent, 557,000 juvenile conch would have to be planted in the sea cages to yield the 500,000 legal-size conch. These farmed-raised conch will produce 100,000 pounds (45,350 kg) of meat at five conch per pound or 0.18 pounds of meat per conch (85 g of meat per conch). The farmer should expect to get a premium price for farm-raised conch based on niche-market prices established by the Caicos Conch Farm (up to \$20.00 per pound wholesale). At this price the annual gross revenue would be approximately \$2,000,000 per year.

The infrastructure required to produce 500,000 conch per year includes an egg farm, a hatchery, a post-larval and nursery facility, and a grow-out pasture (Table 1). If conch will be processed on site, a processing facility is also required. It is estimated that 12 staff members would be needed to operate the onshore and offshore facilities of a farm this size.

Table 1. Production of 500,000 queen conch from egg stage to legal market size.

Stage	Production numbers (rounded to nearest 1,000)	Survival %	Time	Size (shell length)	Stocking density	Type of system and number of production units
Egg farm	60 females:60 males; 2.5 egg masses/day	100%	March - October	7 - 9 in (18 - 23 cm)	1 conch/100 ft ² (1 conch/10 m ²)	12,900 ft ² (1,200 m ²) of offshore fore reef habitat
Egg mass	200,000 viable eggs/egg mass; 70 egg masses/year	—	April - September	—	1 egg mass/container	18 egg incubation containers (6 in dia x 6 in high; 15 x 15 cm)
Hatchery (larviculture)	13,750,000	10%	21 days	0.3 - 1 mm	2 egg masses/larval tank; 760 veligers/gal (200/L) at hatch and 95/gal (25/L) near metamorphosis	18 larval tanks (530-gal; 2,000-L); 20- to 65-gal (250-L) algae cylinders
Metamorphosis	1,375,000	60%	14 days	1 - 3.5 mm	325/ft ² (3,500/m ²)	50 shallow tanks with screen trays; 20 2,100-gal (8,000-L) algae tanks
Nursery – early	825,000	75%	13 weeks	0.14 - 0.8 in (3.5 - 20 mm)	316/ft ² (3,400/m ²)	36 tanks with sand substrate
Nursery – late	619,000	90%	48 weeks	0.8 - 2.8 in (2 - 7 cm)	14/ft ² (150/m ²); reduce to 7/ft ² (75/m ²)	25 ponds with sand substrate
Grow-out in cages in the sea pasture	557,000	90%	20 months	2.8 - 7 in (7 - 18 cm)	Pasture: 1 - 2 conch/10 ft ² (1 - 2 conch/m ²) Cages: 1 conch/ft ² (10 conch/m ²)	For cages: 100 acres (40 hec); 100 cages (5,400 ft ² ; 500 m ²)
Market	500,000	—	—	—	—	—

Summary

The queen conch, *S. gigas*, is a prized delicacy throughout the Caribbean and Florida and has long been harvested both for its meat and its beautiful shell. Commercial fishing has depleted wild populations. Culturing queen conch could relieve fishing pressure and provide animals for restocking overfished habitats. Methods of culturing juvenile queen conch are well established. Egg masses are collected from the wild and the hatched veligers are cultured for 21 days on phytoplankton. After metamorphosis, the post-larval conch are grown on sand in shallow tanks until they are almost 1 inch (2 cm) SL. They are fed a combination of flocculated phytoplankton and prepared feed. Conch are kept in nursery ponds onshore until they are 2.8 inches (7 cm) SL. Then they are placed in a sea pasture for grow-out. Small juvenile conch are marketed as specialty food. Legal-size conch are used in more traditional dishes such as conch fritters, salad or chowder. To be economically

sustainable, a commercial conch farm should produce 500,000 juvenile conch per year.

Acknowledgements

Special thanks to Amber Shawl, Ashley Spring, Peter Van Wyk and Nancy Daves, who contributed information for this publication. This is Harbor Branch Oceanographic Institution, Inc. contribution # 1605.

Suggested readings

Davis, M. 2000. Queen conch (*Strombus gigas*) culture techniques for research, stock enhancement and growout markets. Pages 127-159 in M. Fingerma and R. Nagabhushanam, editors. Marine Biotechnology. Science Publishers, Inc., USA.

Davis, M., B. A. Mitchell and J. L. Brown. 1984. Breeding behavior of the queen conch *Strombus gigas* Linne held in a natural enclosed habitat. *Journal of Shellfish Research* 4:17-21.

Delgado, G. A., C. T. Bartels, R.A. Glazer, N. J. Brown-Peterson and K. J. McCarthy. 2004. Translocation as a strategy to rehabilitate the queen conch (*Strombus gigas*) population in the Florida Keys. *Fisheries Bulletin* 120:278-288.

Randall, J. E. 1964. Contributions to the biology of the "queen conch" *Strombus gigas*. *Bulletin of Marine Science of the Gulf and Caribbean* 14:246-295.

Shawl, A. and M. Davis. 2004. Captive breeding behavior of four Strombidae conch. *Journal of Shellfish Research* 23:157-164.

Stoner, A. W. 1994. Significance of habitat and stock pre-testing for enhancement of natural fisheries: experimental analyses with queen conch. *Journal of the World Aquaculture Society* 25:402-424.

SRAC fact sheets are reviewed annually by the Publications, Videos and Computer Software Steering Committee. Fact sheets are revised as new knowledge becomes available. Fact sheets that have not been revised are considered to reflect the current state of knowledge.



The work reported in this publication was supported in part by the Southern Regional Aquaculture Center through Grant No. 2003-38500-12997 from the United States Department of Agriculture, Cooperative State Research, Education, and Extension Service.