



MANAGEMENT OF  
RECREATIONAL  
AND  
FARM PONDS  
IN LOUISIANA





## FARM PONDS

---

A farm pond or recreational pond can serve many purposes: a source of food, an aesthetic enhancement to property, a sportfishing opportunity, a swimming area, wildlife habitat, or a reservoir for livestock, irrigation and fire fighting needs. The intended purpose or purposes should be well thought out before construction and stocking. This publication reviews planning considerations and management recommendations relating to a number of potential uses for small ponds in Louisiana.



# TABLE OF CONTENTS

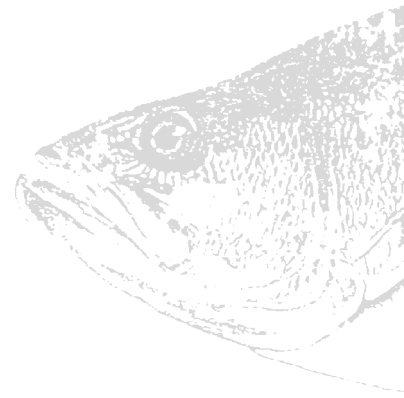

---

<b>LEGAL CONSIDERATIONS</b> .....	6
Permitting .....	6
Public Lands and Waters .....	6
Other Regulations .....	6
Liability .....	6
<b>ALTERNATE USES FOR PONDS</b> .....	8
Livestock Watering .....	8
Fire Control .....	8
Wildlife Habitat .....	8
Swimming .....	8
<b>DESIGN AND CONSTRUCTION</b> .....	10
Location .....	10
Soil .....	10
Pond Size and Shape .....	11
Water Supplies, Water Loss and Pumping .....	11
Clearing the Pond Site .....	12
Levees .....	12
Drainage .....	13
Sealing Ponds .....	13
Improvements to Existing Ponds .....	14
<b>POND HABITAT DEVELOPMENT</b> .....	15
Depth Considerations .....	15
Habitat Complexity .....	16
Spawning Areas .....	17
<b>WATER QUALITY</b> .....	18
Water Characteristics .....	18
Surface Water .....	18
Groundwater .....	19
<b>TURBIDITY - MUDDY WATER</b> .....	20
<b>FERTILIZATION</b> .....	21
Should You Fertilize? .....	21
Types of Fertilizer .....	21
Fertilization Methods and Schedules .....	22
Applying Fertilizers .....	22
<b>LIMING PONDS</b> .....	24
Liming Materials .....	24
Soil Samples .....	24
Application Methods .....	24
Frequency of Liming .....	25

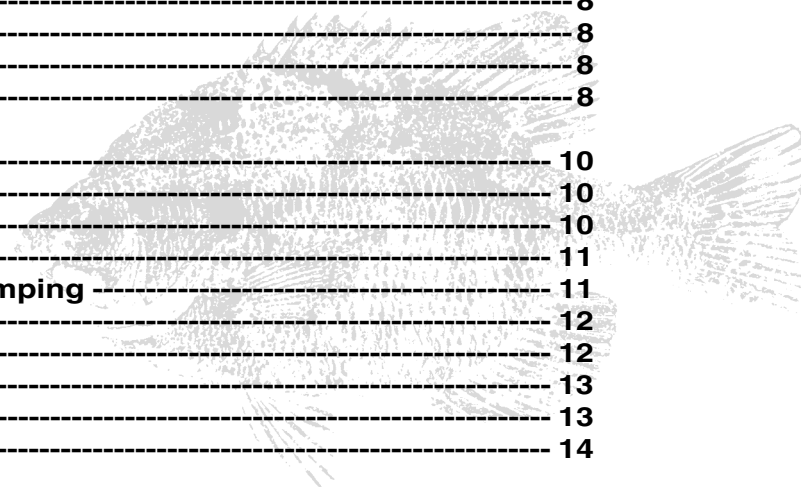

<b>SPECIES PROFILES FOR STOCKING</b> .....	<b>26</b>
<b>Bream</b> .....	<b>26</b>
<b>Bass</b> .....	<b>27</b>
<b>Catfish</b> .....	<b>27</b>
<b>Forage Species</b> .....	<b>28</b>
<b>Fish to Avoid</b> .....	<b>28</b>
<b>Recommended Stocking Combinations</b> .....	<b>29</b>
<b>STOCKING PROCEDURES</b> .....	<b>32</b>
<b>Acclimation Procedures</b> .....	<b>32</b>
<b>OXYGEN DEPLETIONS AND OTHER TYPES OF FISH KILLS</b> .....	<b>33</b>
<b>Algal Blooms and Oxygen</b> .....	<b>33</b>
<b>Other Algal Bloom Impacts</b> .....	<b>34</b>
<b>Response Options - Aeration</b> .....	<b>34</b>
<b>Fish Kills from Chemical Contamination</b> .....	<b>34</b>
<b>DISEASES IN POND FISHES</b> .....	<b>35</b>
<b>The Role of Stress</b> .....	<b>35</b>
<b>What to Look For</b> .....	<b>35</b>
<b>What to Do</b> .....	<b>36</b>
<b>Internal Parasites</b> .....	<b>36</b>
<b>MANAGING BASS AND BREAM POPULATIONS</b> .....	<b>37</b>
<b>RENOVATION OF PONDS</b> .....	<b>40</b>
<b>Determining Pond Volume</b> .....	<b>40</b>
<b>Application Rates and Procedures</b> .....	<b>40</b>
<b>Restrictions</b> .....	<b>41</b>
<b>AQUATIC WEED CONTROL</b> .....	<b>42</b>
<b>Factors Affecting Control</b> .....	<b>42</b>
<b>Pond Construction</b> .....	<b>42</b>
<b>Preventive Fertilization</b> .....	<b>42</b>
<b>Drawdown</b> .....	<b>43</b>
<b>Mechanical Control</b> .....	<b>43</b>
<b>Biological Control</b> .....	<b>43</b>
<b>Chemical Control</b> .....	<b>43</b>
<b>NUISANCES AND PREDATORS</b> .....	<b>45</b>
<b>Furbearers</b> .....	<b>45</b>
<b>Snakes</b> .....	<b>45</b>
<b>Turtles</b> .....	<b>45</b>
<b>Birds</b> .....	<b>45</b>
<b>Mosquitoes</b> .....	<b>45</b>





## LEGAL CONSIDERATIONS

---

### Permitting

Pond-related permitting begins with the site selection and construction phases. Non-wetland construction in an upland area outside the coastal zone, in an area higher than 5 feet above sea level or in a fastland within the coastal zone, requires no permit from the U.S. Army Corps of Engineers, Coastal Management Division or the Environmental Protection Agency, but local ordinances should be checked for site selection/construction requirements. If the project causes discharges into coastal waters or changes existing water flow into coastal waters, a permit may be needed.

If water bottoms or wetlands are affected by the construction, contact the U.S. Army Corps of Engineers or the Natural Resources Conservation Service. Under state law, within the coastal zone - below 5 feet and not in a fastland - dredging, filling or construction and operation of water control structures, including levees, all require a state or local coastal use permit.

### Public Lands and Waters

Anywhere in the state, any activity encroaching on state lands or state-owned water bottoms must be permitted by the Division of Administrations' State Lands Office. As for federal law, any obstruction of navigable U.S. waters or discharges of dredged or fill materials into such waters require a permit from the Army Corps of Engineers.

Note that public waters may be diverted for private use -- unless regulated by laws related to coastal zone management -- so long as such waters are returned to their natural channel after use. Also, federal law may require a permit for any diversion of water from a navigable river.

Any well that produces more than 50,000 gallons of water/day must be registered with the Department of Public Works. Wells drilled after July 26, 1972, that are free-flowing and produce more than 25,000 gallons/day must have control devices.

### Other Regulations

The use of chemicals is regulated by Food and Drug Administration and the EPA. Stocking also requires regulatory compliance. Many exotic species may not be brought into the state without permits from the Louisiana Department of Wildlife and Fisheries, and some -- such as the piranha -- are absolutely prohibited. Many fish predators are protected by federal and state endangered-species laws. Before taking action against birds or other predators, pond owners should consult the appropriate laws through the Department of Wildlife and Fisheries.

### Liability

Along with regulations, legal liability for accidents occurring on a pond owner's property must be considered. Most Louisiana legal cases involving pond-related accidents deal with children wandering onto property and drowning in a small water hole, such as a borrow pit. Plaintiffs in these cases usually base their claims on the "attractive nuisance doctrine," which has two requirements to make the defendant liable. First, the nuisance must have some artificial or otherwise special feature that makes it especially dangerous to children, or the danger must be a hidden one. Second, the child must be so young as not to be responsible.

Many plaintiffs have lost cases because there was nothing especially "attractive" about the defendants' ponds or borrow pits, and/or the children involved were teen-agers capable of understanding

the danger. Defendants were also helped because they had fences and their ponds were in fairly remote areas, away from areas children would usually be in.

Also be aware of the legal concept of “strict liability,” which means exactly what it sounds like. Some activities are judged to be so dangerous that they will result in legal liability if anyone is harmed because of them. If a court establishes that the owner of a pond has some duty to keep it safe to the public, and finds that the plaintiff in a particular case was hurt in that pond because it was not safe, then the owner will be liable.

Fortunately for pond owners, such duty has rarely been established for owners of ponds and

pits, usually because they are not in areas frequented by the public. Trespass laws may help, because they state that under the law the public has no business on pond owners’ property. However, if for some reason a court in a particular case finds a duty under strict liability analysis, the defendant will be found liable.

Another possible source of liability for pond owners is runoff. Any obstruction of, or change of, natural drainage that affects neighboring property is a source of possible liability. If any trash or chemicals get into public waters because of the runoff, then the pond owner could also be subject to direct fines by state agencies. For this reason, all drainage should be planned and controlled.

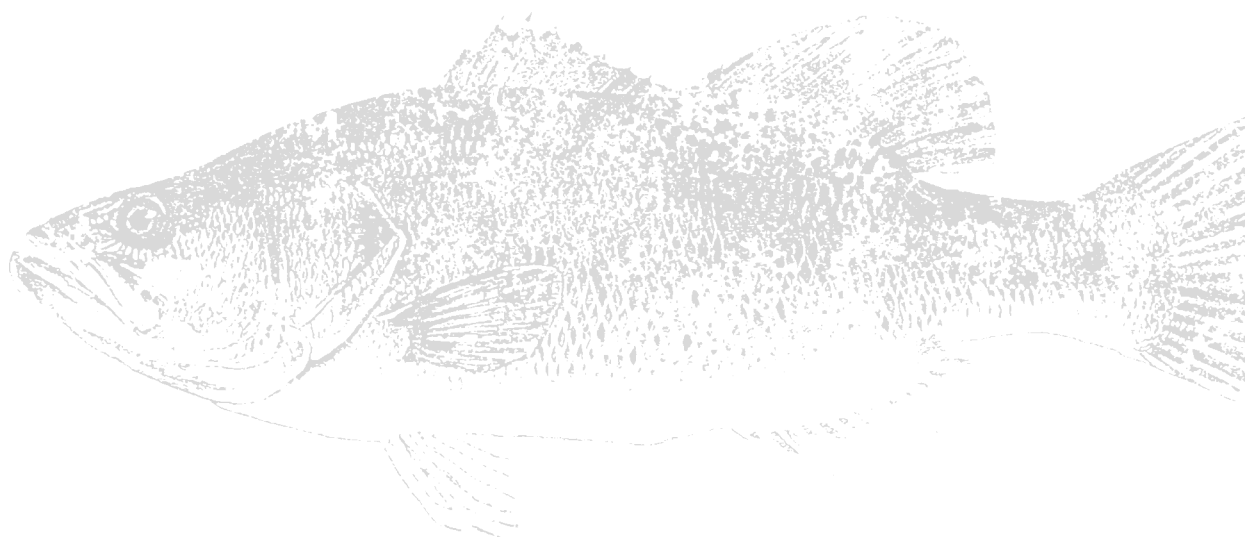
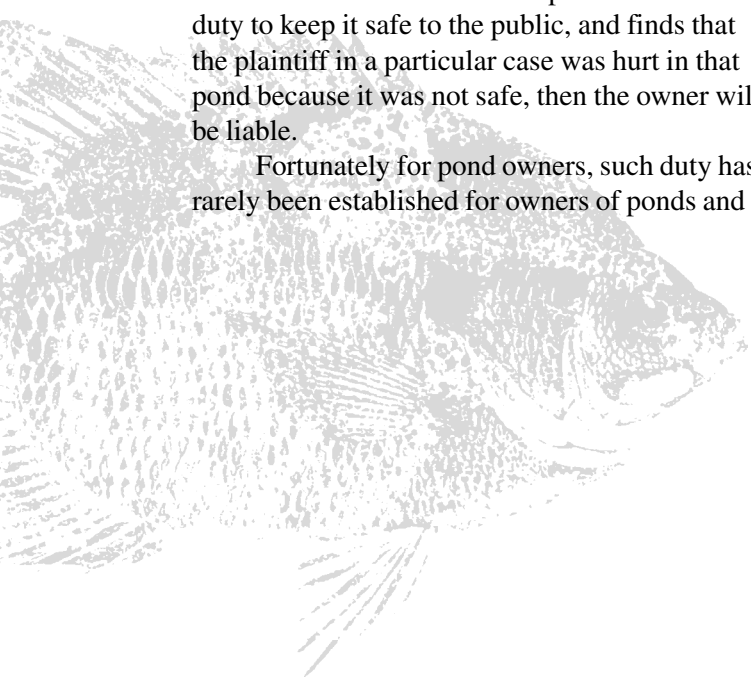



## ALTERNATE USES FOR PONDS

Many small farm ponds are used for livestock watering, rural fire control, waterfowl and wildlife habitat, and improving the landscape. Although many of these uses are generally compatible, certain management practices or modifications may be required. These options should be considered before constructing a pond, if possible.

### Livestock Watering

When livestock are allowed direct access to watering ponds, they tend to stir up mud and cause excessive turbidity, reducing pond productivity, spawning success and quality of fishing. This problem can be eliminated by constructing or modifying drainage structures to allow for watering troughs outside the pond and by limiting shoreline access by livestock. Ponds used for watering livestock should be well-spaced throughout the grazing area. In smooth, level areas, livestock should not have to travel more than one mile to reach a watering pond. This distance should be reduced to 1/4 mile in rough, hilly country. (see Figure 1)

### Fire Control

If ponds are to be relied on for fire control, adequate pumping equipment and hoses will be required. Plan to use a stream of at least 250 gallons per minute at a pressure of no less than 50 psi. This rate of usage will consume 1/4 acre-foot in a 5-hour period. Install at least one dry hydrant, and secure a centrifugal pump and an appropriate length of high-quality fire hose with a nozzle. (see Figure 2)

### Wildlife Habitat

Ponds can attract many types of wildlife if human disturbances are minimal and sufficient cover and access are provided. Migratory waterfowl often use relatively isolated ponds as temporary resting places and feeding sites. A shallow area can be developed along one side of the pond to enhance wildlife use, but this shallow habitat may complicate weed control if the rest of the pond does not have a steep drop-off.

### Swimming

If ponds are to be used for swimming, they should be free from potential pesticide or sewage contamination and submerged obstructions such as logs, branches, stumps or old fencing. A relatively shallow, gently sloping area is recommended to facilitate access.







**Figure 1. Modified drain to service a watering trough**

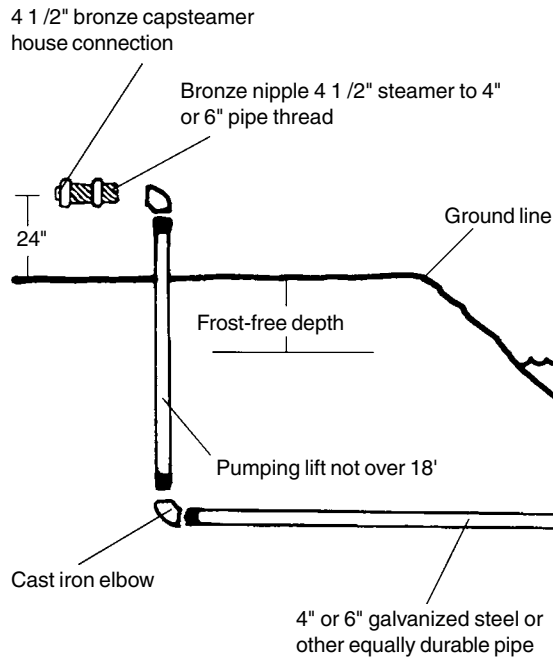
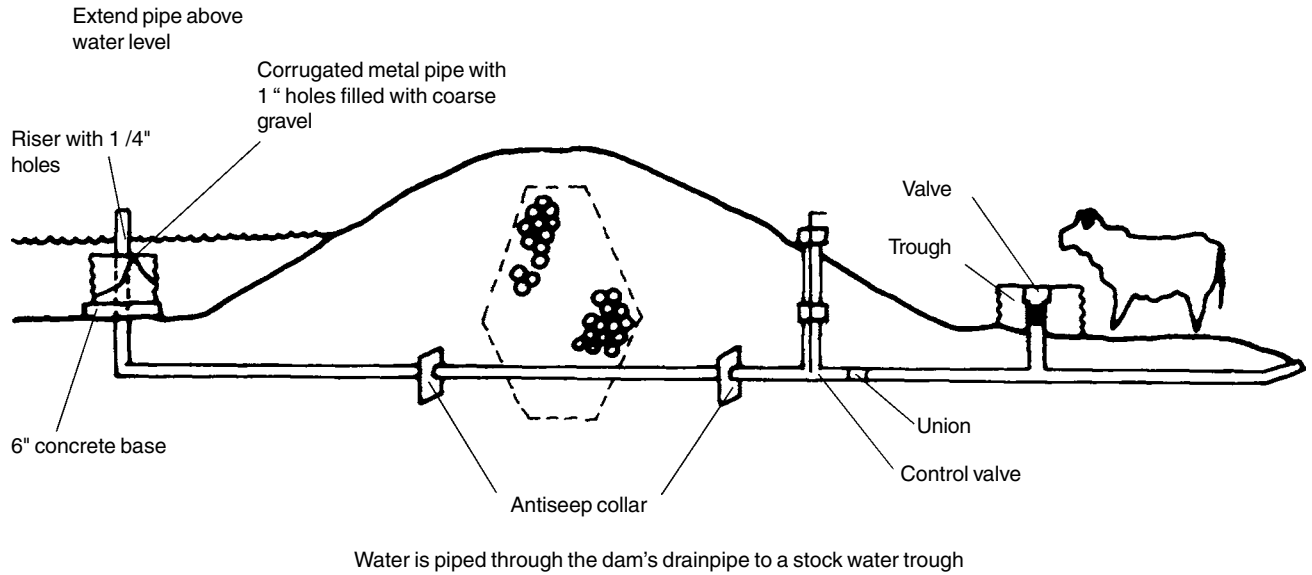

**Figure 2. Fire control apparatus**

A Typical Dry Hydrant System

# DESIGN AND CONSTRUCTION



**Satisfaction and enjoyment from a pond begin with proper design and construction. A well-designed and constructed pond is a major capital investment. It can enhance property values or be nothing more than an attractive nuisance that may increase insurance costs.**

## Location

A desirable pond site should have three characteristics: an adequate supply of good quality water, topography that can be economically converted into a pond and soil that will hold water. A well-constructed, properly located pond will provide better service and last longer while requiring less maintenance. Before beginning construction, make a master plan involving the pond and other property features. Plan ahead to avoid later problems. Changes are easy to make on paper but are costly once the pond is built.

A number of questions must be considered seriously during the planning stage: Will the pond be built on owned property or leased property? Will it be a business venture or just a recreational project? Will it be near a public road or the home site, or some distance off the road? What about security and safety? Will the pond be accessible year round? Do you plan to build other ponds later? Will agricultural demands such as irrigation and livestock watering require an auxiliary pond or tank? What about power supply for pumping? Will electricity be required? Will it be single-phase or three-phase electricity?

Before beginning construction, there are even more considerations to address, such as servitudes, rights of way, pipelines, power lines, etc. Will friends or neighbors have fishing rights

and/or hunting privileges? Is there a possible conflict of interest? Will the pond require fencing?

Check with the USDA Soil Conservation Service (SCS) for soil type and topographic maps, as well as aerial photographs. The local office of the SCS can provide valuable assistance in determining if soil types and proposed locations are suitable for pond construction. The Louisiana or U.S. Geological surveys may also have useful maps. Neighbors, surveyors or government planning agencies may also have useful maps and other information.

Although a well-sealed pond with no leakage is the number one concern, adequate drainage is a close second. Where will surplus water go? Fish losses caused by flooding must be avoided. The property's drainage outlet must be considered in the drainage design.

## Soil

Depending on the history of the property, you may need to check for pesticides in the soil where the pond will be located. Request help from your local SCS representative to determine how much sand, silt or clay it contains, to a depth of at least 2 feet below the anticipated pond bottom. The soil needs to have about 25 percent clay or silt to seal properly. Avoid any possibility of roots and limbs in the pond levees or bottom.

Even where clay content is high, soil compaction over the entire water-holding area is essential. This must be done during construction, using a sheep's-foot roller or heavy tractor. Track vehicles do not compact soil as effectively as these methods.

## Pond Size and Shape

Recreational ponds in Louisiana may vary in size from less than half an acre to 20 acres or more. Some factors to consider when

determining the size of a pond include primary and secondary uses, watershed or groundwater yields and cost. Ponds may be irregular in shape, especially dam ponds between two hillsides. On level ground, ponds are frequently rectangular or square with levees on all sides. These are referred to

as levee ponds. A third type of pond is the excavated, or dug out, borrow pit pond. These may have partial levees with one side open to receive surface runoff from rains. (see Figures 3, 4 and 5)

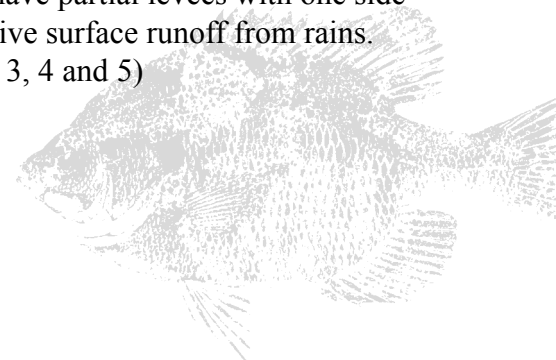

**Figures 3 and 4. Various illustrations of pond layouts**

**Figure 3**

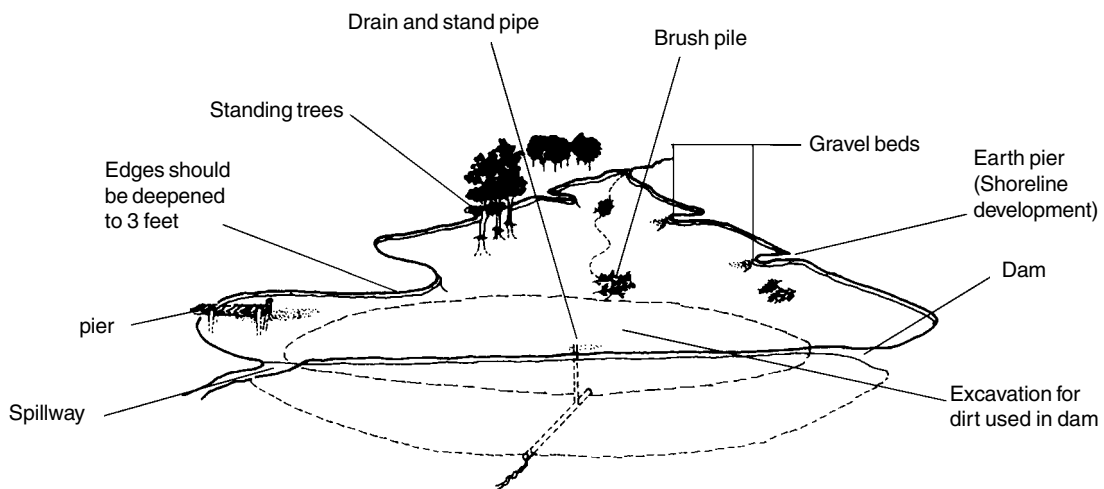

**Figure 4**

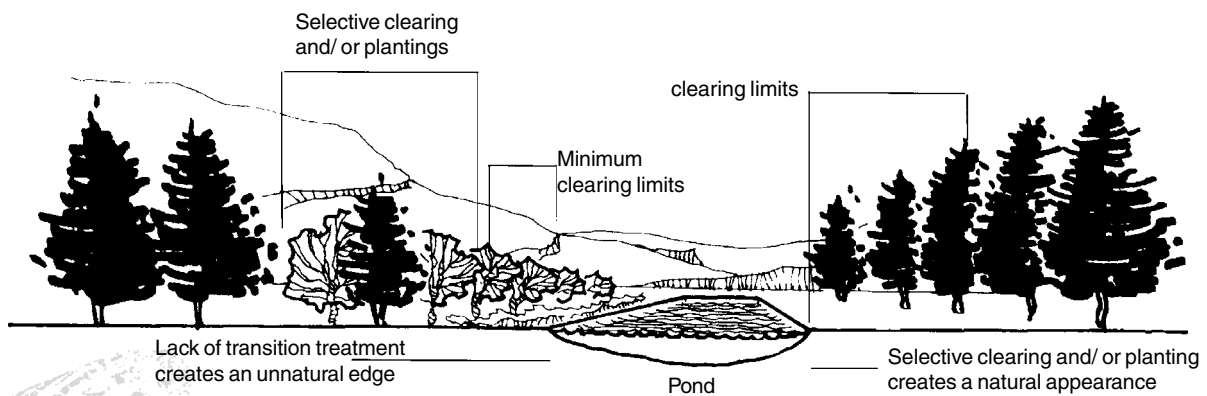
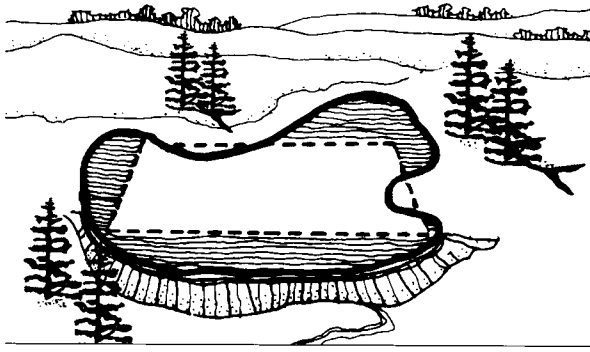

Figure 5. Pond Layout



## Water Supplies, Water Loss and Pumping

Pond water may come from rainfall, surface runoff or pumped-in groundwater or surface water. Rain falling directly into a pond will not maintain adequate pond water levels, so watersheds above the pond elevation are used to funnel larger areas of rainfall into many ponds. Watersheds usually range from five to 20 times the pond surface acreage. Heavy clay soils and open pastures allow for smaller watersheds, and sandy soils and forested areas demand larger watersheds. If large portions of a watershed are not properly vegetated, water runoff will deposit excessive amounts of silt in the pond and greatly shorten its productive lifetime.

Avoid excessively large watersheds, because they increase size requirements of levees and associated construction costs. More important, oversized watersheds result in excessive flushing. For the same reason, do not locate ponds over stream beds or ditches where water will flow through continuously. If these situations cannot be avoided, ponds may still be built and managed successfully if a diversion channel can be incorporated into the design at the time of construction.

If groundwater is used for pond filling and evaporation replacement, the well should be located near the edge of the pond or in a central location if more than one pond will be supplied from the same well. If the pond is to be used for irrigation in addition to fishing, water storage should be approximately 1.5 acre feet for each 1.0 acre to be irrigated.

Water is lost from a pond by seepage, drainage, evaporation or overflow. Seepage loss can be minimized by proper sealing and compac-

tion of the pond bottom, levee and sides. However, sand layers or isolated sand pockets and stump holes can cause severe seepage problems and must be avoided. Sudden water loss can occur if a levee fails or a drain pipe cracks or is left open. Depending on the time of year and the elevation of the leak, fish losses may be unavoidable in these situations.

Evaporation is usually negligible in the winter, but can be as much as 1/5 inch per day or more in Louisiana on hot windy days. Unless this water loss is replaced by pumping, the water level will continue to drop until the next rain. These losses can amount to as much as 1 inch per week. A loss of 1 acre-inch in one week is equal to 27,154 gallons, or 3,879 gallons per day.

Pumps used for filling and maintaining ponds are of three general types: (1) centrifugal, (2) deep well-turbine and (3) low lift. A small pump can maintain a pond level once it is full, assuming seepage is small. A pump will require a capacity of about 12 to 15 GPM per pond surface acre to offset a total water loss of 0.3 inches per day, pumping 12 hours per day. This will require 0.5 to 3.0 horsepower, depending on well depth and pressure.

If pumping 24 hours per day and using automatic float controls, the flow rate could be 6 to 7.5 GPM per pond surface acre to offset a total water loss of 0.3 inches per day. A flow rate of 450 GPM is equal to 1 acre-inch per hour and also equal to 1.0 cubic foot per second (CFS). For example: pumping 450 GPM for 12 hours will fill a one-acre pond with 12 inches of water.

## Clearing the Pond Site

The entire pond basin, plus an open strip at least 20 feet back from the water line, should be cleared of all trees, stumps, brush, dead branches and other debris. When timber is present, irregular variation in the width of the open strip surrounding the pond will add to a more natural appearance after construction. Old stumps, trees and branches should especially be avoided in the area where the levee will be constructed. These materials will gradually rot if buried in the levee, providing a direct channel for water to leave the pond. The area where the base of the levee will be located should be scraped clean of leaves, grasses, muck and topsoil.

## Levees

Although fish pond levees vary widely in height from one site to another, they should be at least 6 to 8 feet high. A minimum average depth of 4 feet should be maintained throughout the year, and design specifications should make sure no part of the pond is less than 3 feet deep to avoid problems with rooted aquatic vegetation. Conversely, water depths of more than 6 feet are generally of little use in Louisiana and do not increase overall fish production.

Depending on how efficiently soil is compacted during the construction process, levees may require 15% to 20% additional height to compensate for settling during the first one or two years. Lighter soils may require use of a central clay core to prevent excess seepage through the levee. This should be determined with your SCS representative during the soil evaluation process.

Pond levees should be 10 to 16 feet wide to accommodate bulldozer construction and vehicle traffic. Side slopes usually vary between 3:1 and 5:1. If you have any doubts regarding design specifications, consult your SCS representative or a qualified engineer.

Levee surfaces should be protected with grass sides, gravel tops and riprap along downwind interiors. Establish a grass cover on new levees as quickly as possible. Common causes of damage to levees after construction include intrusive tree roots, cattle damage, extreme wave action and excessive vehicular traffic.

## Drainage

Drain structures and pond locations should allow for complete drainage when needed. Levee ponds need a pipe drain through the levee in the lowest part of the pond for gravity drainage. Otherwise, pump-outs will be necessary sooner or later. A level-control drain pipe is often recommended to regulate water depth automatically. Gate or shear valves should be incorporated outside the levee to allow for easy depth adjustment, especially for winter drawdowns. The inside pipe should be equipped with a screen, cage or gravel-bed filter to prevent clogging or stopping up with mud, vegetation or other debris.

Ponds smaller than eight acres should have 6-inch diameter drain pipes. Ponds from eight to 12 acres require 8-inch pipe, and larger ponds generally require 12-inch diameter drain lines for responsive

water control. Drain pipes should extend at least 2 feet beyond the toe of the levee on both sides. Once drain lines are laid, concrete collars should always be installed at 12-foot intervals before continuing with levee construction.

Rainfall in most parts of Louisiana usually ranges from 45 to 60 inches per year, but this rainfall is distributed variably from day to day and week to week. Because of this variability, a spillway should always be provided for emergency drainage when excessive rains occur. Spillways can be excavated channels or can be constructed with piping equipped with trash racks. Pipe spillways are generally of two types: drop-inlet or hooded-inlet, both of which pass through the levee. Excavated spillways must be wide and flat to avoid erosion and fish loss during heavy water flow. (see Figures 6 and 7)

Your SCS representative can provide guidelines for sizing either type of spillway, but a good rule is to make an excavated spillway width equal to at least 10% of the length of the levee. For long, narrow ponds, increase this amount. To discourage fish from leaving the pond, water flow through the spillway should not exceed 3 inches in depth. Although spillways are usually inactive except during heavy rains, a good turf cover should be established on excavated spillways after construction and maintained at all times. For ponds with large watersheds, levees must be constructed to allow at least 2-2 1/2 feet for temporary floodwater storage while excess water is drained through the spillway.

If water will be required frequently for watering livestock or other purposes, a line can be tied in to the main drain pipe outside the levee and fitted with a gate or float valve to fill a tank, trough or smaller pond. Fencing may be required to discourage livestock from using the main pond. Uncontrolled livestock watering will damage levees and will eventually ruin the fishing in small or moderately sized ponds.

## Sealing Ponds

The entire pond bottom must be sealed to a point well above the anticipated waterline to prevent water seepage. This is normally done by using soil with at least 25% clay, which swells when wet to fill in spaces between soil particles. This layer is disked or mixed uniformly and then packed tight with a sheep's-foot roller.

Small amounts of seepage through levees are common in new ponds. This condition usually corrects itself as levees settle and clay particles become saturated and swell. If seepage continues or leaks develop, it may be necessary to drain the pond partially or completely and apply bentonite, a volcanic clay compound, to the inside surface of the levee. SCS representatives can provide advice if this is necessary. Leaks larger than 1/2 to 1 inch in size often require more extensive repairs with heavy equipment after partially or completely draining the pond. Again, contact SCS if leaks persist.

## Improvements to Existing Ponds

Most construction-related management problems in existing ponds are the result of insufficient water control or excessively shallow pond edges. Water control can often be improved by installing proper drain structures. In some instances, diversion channels are required to eliminate constant flushing and allow for fertilizer to be retained in the pond. If spillways are not present, they should be installed to minimize levee damage. Shallow pond edges can be corrected by cutting below the water line and using the spoil to build up levees or make points extending out into the pond.

Figures 6 and 7. Drainage structure options

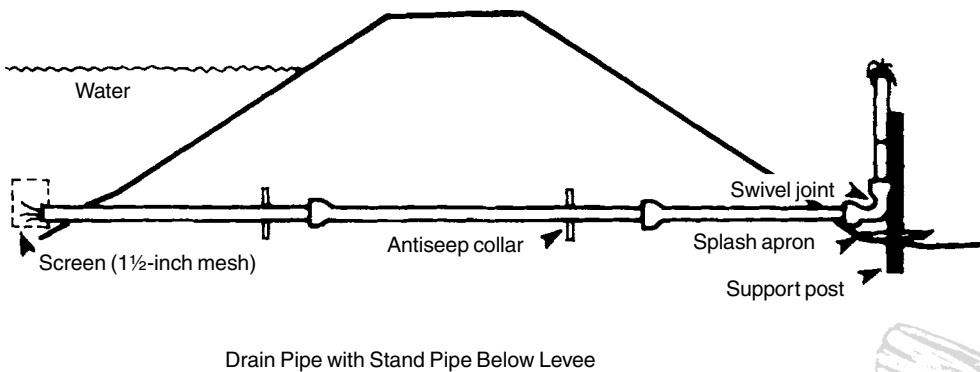
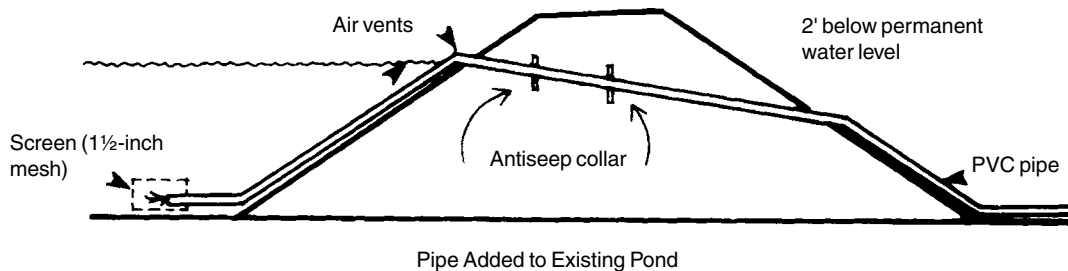

# POND HABITAT DEVELOPMENT

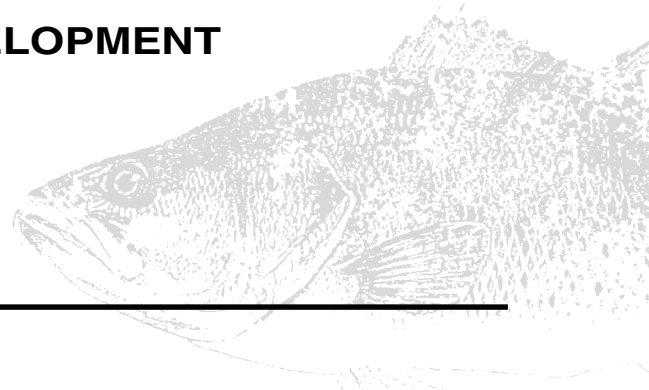

To develop a successful fishery, farm ponds must provide habitat that will promote adequate reproduction and good growth of fish populations. From this standpoint, several factors could be included under the term habitat.

## Depth Considerations

In general, a deeper pond provides more habitat for fish production. However, as ponds get deeper, there is a greater likelihood of stratification. Deeper ponds can become stratified, with a warm upper level, a transition zone where the temperature drops quickly, called the thermocline,

and a cooler, deeper zone. Problems in deeper ponds develop because oxygen levels in the isolated bottom zone drop throughout the summer and may reach 0. If this happens, available habitat is reduced because fish will avoid this part of the pond. (see Figure 8)

If the pond turns over quickly from a severe windstorm or a heavy, cold rainfall during late summer or fall, a fish kill can occur. The best solution in deeper ponds (large areas over 10 feet in depth) is to install a floating windmill aerator or similar device to keep the water column well mixed. This will ensure adequate dissolved oxygen levels in the hypolimnion and will increase the potential for fish production. (see Figure 9)

Figure 8. Stratification

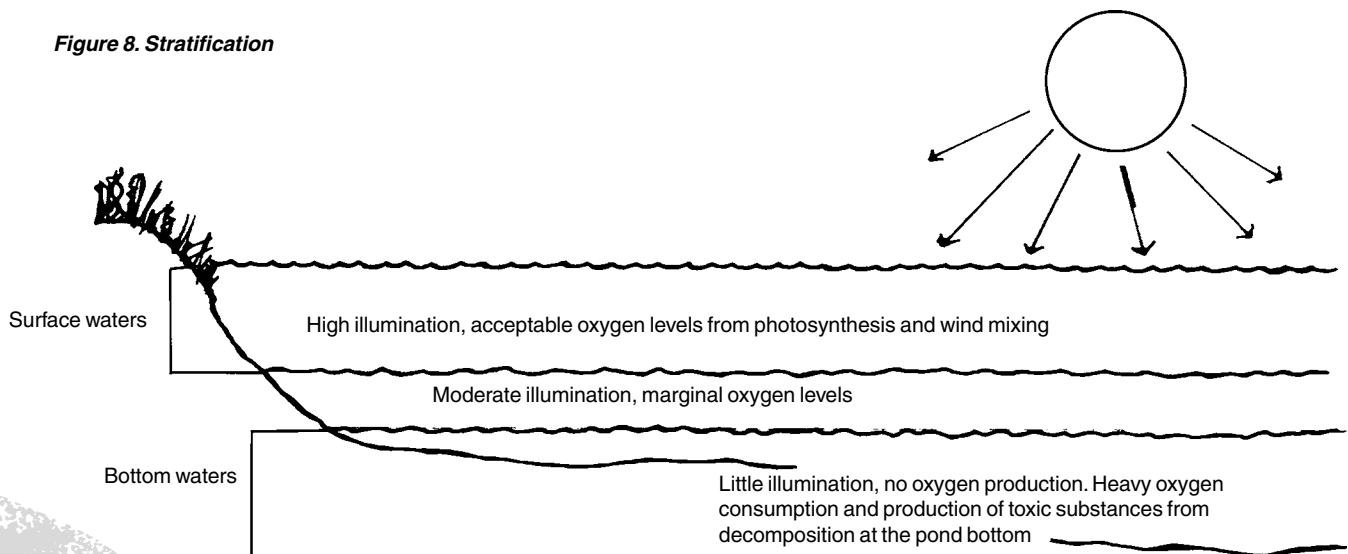
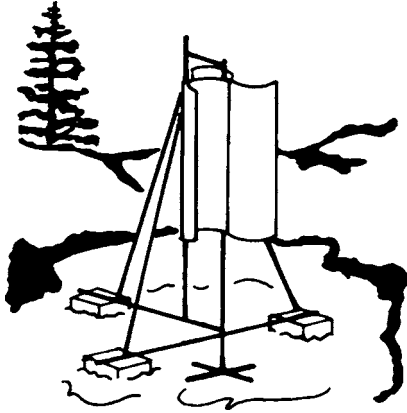

Figure 9. Windmill Mixer



## Habitat Complexity

Apart from water quality and overall pond depth, two other aspects of pond habitat are crucial for developing productive fishing: habitat complexity and spawning areas. One aspect of habitat complexity is variability in depth and shape of a pond. A useful concept that has been developed to describe pond shape is the shoreline development index. This index compares the length of the shoreline of a pond to the circumference of a circle with the same surface area. A higher shoreline development index provides much better habitat for fishes that are suited for farm ponds in Louisiana such as largemouth bass, bluegill sunfish, redear sunfish and channel catfish. (see Figure 10)

A second aspect of habitat complexity is depth variability. A well-constructed pond should have near-vertical sides to a depth of 3 feet to discourage growth of rooted plants. Moving away from the vertical walls at the edge of the pond, deeper holes, underwater mounds and submerged points all provide habitat variability and cover for sportfishes, particularly largemouth bass. In this regard, ponds formed from dams constructed at the mouth of small hollows often provide better habitat diversity than excavated round or rectangular ponds. A third aspect of habitat complexity is submerged structure. Structure can be formed by anything in the water. It provides hiding places for fish, as well as a place to concentrate fish and increase fishing success. However, the type of structure present can have a tremendous effect on fish production and angling success. In general, the least benefi-

cial structure in a pond is rooted vegetation. The problem with beds of vegetation is that they can become so dense that predatory fishes like largemouth bass are unable to forage effectively; this results in high densities of small sunfishes, which become stunted, attaining maximum sizes of 3-5 inches, and reduces bass reproduction. By maintaining a 3-foot depth at the margin of the pond and following a good fertilization schedule, you can usually eliminate rooted vegetation.

However, if rooted vegetation is not present, what types of cover are available, and what types are best? One of the best types of cover is a submerged tree. Consider a 40-foot tree that has been cut down, trimmed of all branches under 1 inch in diameter and placed in a pond perpendicular to the shoreline with the trunk at the pond's edge. It provides physical structure in the pond, but not dense structure. Small and large fishes can easily swim among the branches, thus allowing predatory bass to crop the young sunfishes.

The tree covers the entire range of depths from the surface at the edge to the bottom toward the middle, increasing habitat complexity. It provides good surface area for development of attached algae communities and the insects that serve as forage for young fishes. It provides protected areas where nestbuilding fishes like bass and sunfish can spawn. Finally, it concentrates larger sunfish and bass to increase the catch rate of pond anglers. In general, the more cover/depth combinations that can be developed, the better the habitat.

Other types of submerged structures provide excellent cover for pond fishes, and they all share at least some of the above characteristics. Brush piles that are lashed together and weighted provide excellent cover. Several brush piles can be placed at different depths and locations in a pond to increase habitat complexity. Tire reefs can be made inexpensively. Tire reefs provide low-density cover for a long period of time and are fairly easy to build and anchor. Construction and placement are easiest before the pond is filled or if the pond can be drawn down and then refilled after the reefs have been constructed. Piles of concrete blocks or other materials can also provide cover. In fact, the only real limitations to providing submerged structures are finding heavy materials and getting them into the water. (see Figures 11, 12 and 13)



## Spawning Areas

The other important aspect of pond habitat is spawning substrate (what the bottom is made up of). Largemouth bass and bluegill are nestbuilders, and they prefer a substrate that is fairly firm and coarse. Fairly new ponds with clay bottoms will usually provide adequate spawning substrate for pond fishes. Older ponds, however, tend to become silty, and in time the buildup of this fine mud can reduce nesting success. Check to see that there is some firm substrate in 3-6 feet of water along the

windward shoreline (so that the most of wave action will be at the other end of the pond). If these conditions are not present, the substrate can be improved by spreading pea gravel (1/8 inch to 1/4 inch in diameter) along 50-100 feet of shoreline (5- to 10-foot band, 1/4-1/2 inch deep) or along patches of shoreline around the pond.

*Figure 10. Shoreline Development*

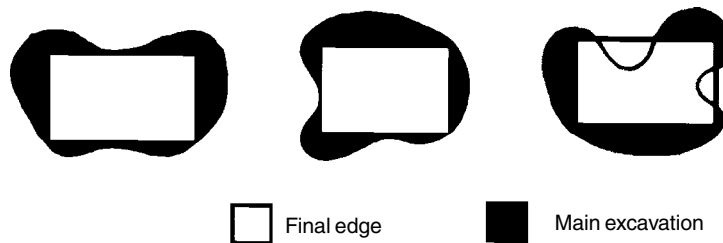

*Figures 11, 12 and 13.*

*Figure 11. Stake reefs*

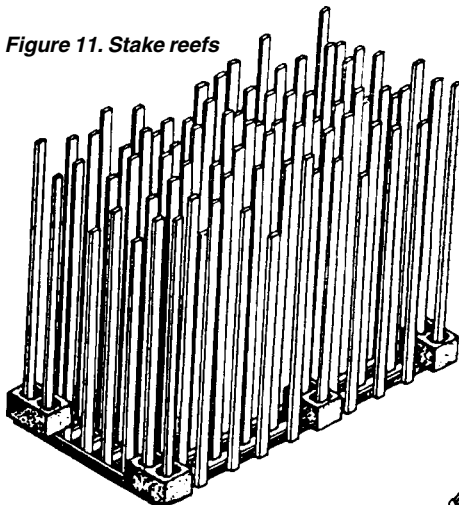

*Figure 12. Brush piles*



*Figure 13. Tire reefs*

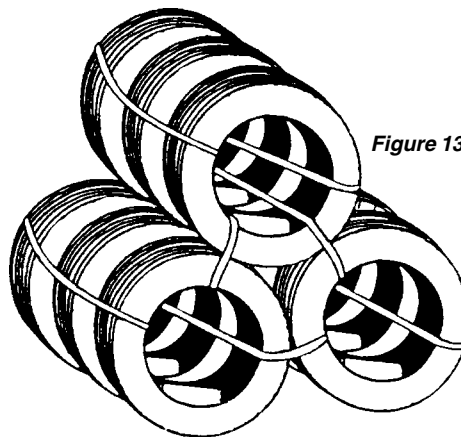



# WATER QUALITY

---

**Good water quality plays a major role in the success of recreational and farm ponds. Water quality is one of the most important limiting factors in the ability of ponds to produce quality fishing. The behavior, feeding, growth and survival of fish in ponds are all affected by water quality. Poor water quality may trigger a disease outbreak and will reduce fish growth and yields. Fishing success may be limited as well. In extreme cases, bad water can cause catastrophic fish kills where most or all fish in a pond die suddenly. Most problems associated with poor water quality can be avoided by understanding the factors which affect water quality and taking proper management measures.**

## **Water Characteristics**

Water used to fill ponds must be of high quality and free of pollutants such as sewage and toxic chemicals. Water that is suitable for livestock and home use or that supports wild fish populations is generally safe and suitable for use in farm ponds.

Fish grow best in water with certain chemical characteristics. Ideally, water should have a pH of 6.5 - 9.0, total hardness of 50 - 300 mg/l and total alkalinity of 50 - 300 mg/l. Total hardness and alkalinity should not be less than 20 mg/l. Most freshwater sources across Louisiana will meet these criteria and be suitable for fish. Simple water tests can determine whether or not your water meets these basic guidelines. Other important factors include maintaining suitable oxygen levels and controlling turbidity (muddy water or phytoplankton).

## **Surface Water**

Most ponds in the state are watershed ponds which depend totally on rainfall runoff across pastures or woodlands to fill and maintain water levels. Water quality is affected by the type and soil composition of the watershed. Waters of low alkalinity usually originate from acid soils. Waters with higher alkalinities drain across soils with sufficient quantities of limestone.

Watersheds must be well vegetated to keep pond water from becoming turbid with mud. Runoff from cropland is not suitable source water for ponds because of potentially harmful pesticide contamination, fertilizer runoff and excessive turbidity. Pastures make good watersheds if not overcrowded with livestock. Too many animals on a pasture will result in excess nutrients entering the pond, causing serious problems with water quality. Ponds receiving water runoff from feedlots or crowded pastures often resemble sewage lagoons and make poor fish ponds.

Well-vegetated woodland watersheds are usually excellent sources of water. Runoff is typically clear and free of contaminants, but temporary problems with runoff (muddy water) may occur after heavy logging activity. Water from pine forest watersheds is usually a bit acidic (low pH), and the addition of limestone may be required in some ponds receiving this water.

Canals, streams and rivers may also be used as sources for pond water if certain precautions are taken. Water from these sources is often used when ponds are built in areas with little or no natural watershed, such as in a level field. Many levee farm ponds are filled with water pumped from surface water sources. Surface water may be used if free of contaminants. Water must be carefully filtered with a fine mesh screen to minimize the possibility of stocking ponds with undesirable species of trash fish

like green sunfish, carp and bullhead catfish. Make sure the screen does not clog with debris while pumping, allowing unscreened water to enter the pond.

## **Groundwater**

Groundwater sources such as water wells and natural springs usually provide excellent quality water for farm ponds. Water wells must be used when surface water sources are unacceptable or not available. Wells are expensive to install and operate and must be of sufficient size and discharge capacity to be useful. An undersized well

in an oversized pond may operate continuously and not even keep up with evaporation.

Groundwater is not pure and often contains dissolved gases like carbon and sulfur dioxide and minerals like iron and calcium. Groundwater also contains no oxygen. Aeration of well water can be accomplished by splashing supply water through a series of screens which adds sufficient oxygen and takes care of problem gases and minerals. Well water can be pumped directly into most established ponds without being aerated.

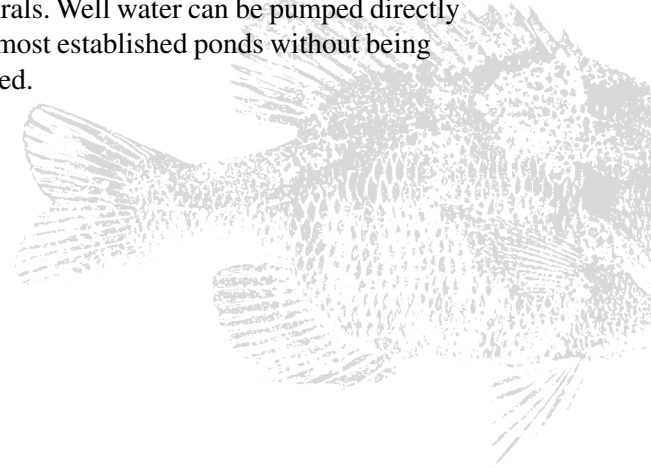

## TURBIDITY - MUDDY WATER

---

**Ponds which remain muddy for extended periods do not produce quality fishing. Muddy water shades out sunlight necessary for the growth and survival of fish food organisms.**

Muddy water is mainly caused by unvegetated watersheds; water entering the pond carries suspended clay and silt particles. Once vegetation problems are solved, so are most muddy water problems. If water remains muddy after revegetation of the watershed, it can be cleared up using several methods:

1. Apply seven to 10 bales of hay or apply barnyard manure at a rate of 1 ton per acre at 3-week intervals until problem is solved. Do not use this treatment during the summer if fish are already stocked because of the danger of oxygen depletion.

2. Add 5 pounds of commercial alum crystals per acre-foot. Occasionally, much higher rates may be required (up to 50 pounds per acre-foot), but alum is acidic, and high treatment rates in low alkalinity waters may kill fish. Always check ponds to determine if liming is required before applying alum.

3. Apply 75 to 100 pounds of cottonseed meal with 25 pounds of normal superphosphate per acre at 2- to 3- week intervals.

4. Apply gypsum (land plaster) at 300 to 500 pounds per surface acre.

5. In mild cases a standard fertilization program can be effective.

All of these measures are temporary. The source of turbidity must be eliminated for the most effective and long-lasting remedy for muddy water.

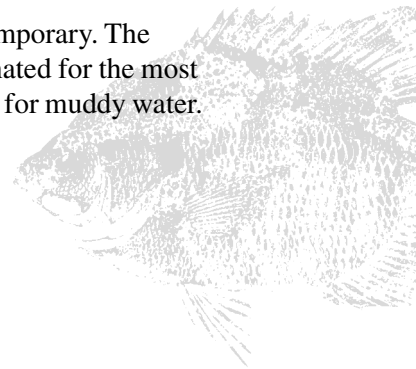
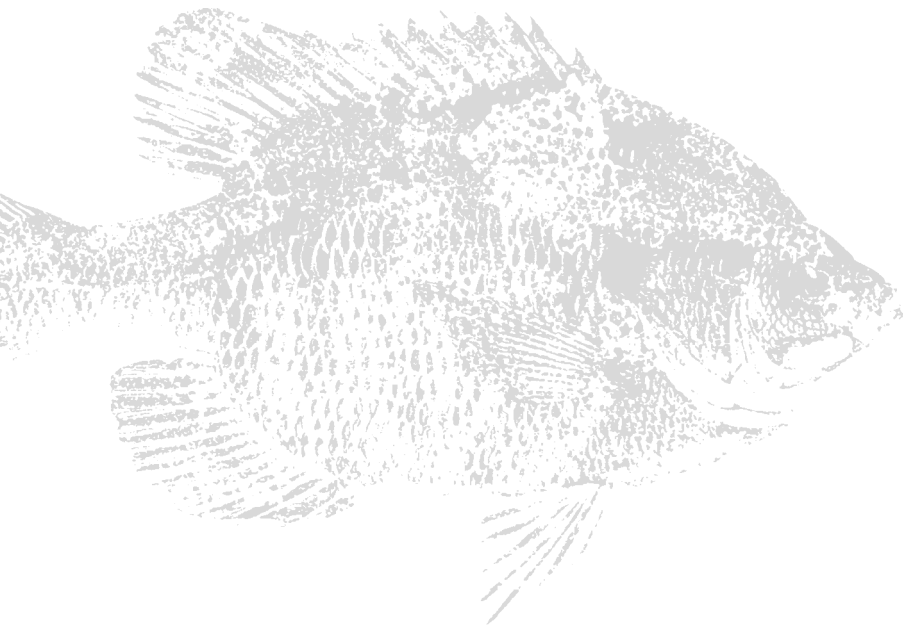



## FERTILIZATION

**Fertilization increases the capacity of a pond to produce fish. Nutrients provided from fertilizer increase production of microscopic plants (phytoplankton) that serve as food for microscopic animals (zooplankton) and aquatic insects. An abundance of these small creatures gives ponds a green color and is called a “plankton bloom.” Plankton and insects serve as food for bream, which are eaten by bass. Fertilization increases the production of natural fish food organisms in ponds. This results in greater fish production and better fishing.**

**Proper use of fertilizer can increase fish yields two to five times. Fish are easier to catch in fertilized ponds because plankton turbidity limits their vision, causing them to be less wary. Plankton blooms also reduce light penetration to pond bottoms, preventing growth of troublesome aquatic weeds. Most ponds will respond to a proper fertilization program. However, muddy ponds and ponds with excessive amounts of water flushing through cannot be fertilized effectively. Ponds with soft, acid water may need to be limed before fertilization may be effective.**

### **Should You Fertilize?**

Not all ponds need to be fertilized. Soils in some areas of Louisiana are high in natural fertility and support excellent fish production without supplemental fertilization. Little or no fertilizer may be needed in ponds receiving runoff from well-managed pastures because of nutrients from manure. Large unfertilized ponds fished by only a few people may produce excellent fishing. Heavily fished ponds should be fertilized for best results.

No pond should be allowed to remain clear. Excessively clear ponds should be fertilized to produce a bloom if only to control aquatic weeds. Fertilizers suitable for farm pond use are available

in liquid or granular form. Liquids are generally cheaper than granules and are superior in promoting phytoplankton growth in ponds. Granular fertilizers, however, may be more readily available than liquids in some areas.

### **Types of Fertilizer**

Complete fertilizers contain nitrogen (N), phosphorus (P) and potassium (K). All fertilizer containers will have the analysis or nutrient content listed. The N-P-K content will be listed in that order. Each number indicates the percentage of weight of each nutrient. An example of a complete fertilizer is 8-8-8, which contains by weight 8 percent N, 8 percent P and 8 percent K. In other words, a 100-pound bag of 8-8-8 contains 8 pounds of each nutrient. The remaining weight (76 pounds) is crushed rock used for filler.

Incomplete fertilizers contain only one or two of the nutrients N, P and K. Common incomplete fertilizer sources are normal superphosphate (0-20-0) and triple superphosphate (0-46-0). Another incomplete liquid fertilizer is ammonium polyphosphate (10-34-0). It contains 10 percent N, 34 percent P and no K. A 100-pound container of this liquid fertilizer contains 10 pounds of N and 34 pounds of P.

Phosphorus (P) is the most important nutrient in pond fertilizers and usually gives a much greater increase in fish production than nitrogen or potassium. An ideal farm pond fertilizer application should contain 4 to 8 pounds of phosphorus and 2 to 4 pounds of nitrogen per surface acre.

Granular and liquid fertilizers are commonly available from agricultural supply stores. Most suppliers have access to liquid formulations made for pond use. Suitable liquid formulations of ammonium polyphosphate fertilizer (10-34-0

and 11-34-0) are also available from many fertilizer bulk plants or agricultural co-ops. Pond owners usually provide their own containers.

## Fertilization Methods and Schedules

Fertilization should begin during the first warm weather in February or March when water temperatures stabilize in the 60s and continue until the water cools in the fall. Applications should be made every two weeks until the water begins to turn a light shade of green with growing plankton. The plankton should become dense enough so that a white disk cannot be seen at a depth of 18 inches. The bottom of a bleach bottle attached to a yardstick works well for checking plankton density in this way. After the desired color is reached, continue applications at monthly intervals or whenever the water clears enough that the disk becomes visible again. Additional fertilizer applications are not necessary unless the pond begins to clear. Disk visibility limited to 6 inches or less, where no muddy water is present, may indicate a problem with overfertilization.

## Applying Fertilizers

Concentrated liquid fertilizer may be sprayed over the shallow water edges of ponds with a power sprayer. A handheld garden sprayer can be used on the edge of small ponds. Liquids may also be applied directly to the pond by siphoning through a small tube (1/4 to 1/2 inch) into the propeller wake of an outboard electric or gasoline motor while moving around the pond. For small ponds (1 acre and less), liquid fertilizer can be diluted by mixing with 10 parts water and splashed over the pond surface. Do not pour liquid fertilizers directly into ponds because they are heavier than water and will flow to the bottom and not mix well.

Granular fertilizers should be kept from direct contact with pond mud if possible because the nutrients become trapped in the mud and not are available to the plankton. A fertilizer platform positioned just under the water surface keeps fertilizer off the bottom, allowing it to dissolve slowly into the water. A platform with a surface area of 45 square feet is sufficient for a 5- to 10-acre pond. Granular fertilizers can be broadcast directly into shallow water, but the platform

method is superior. Bags of fertilizer may be cut open and placed directly in shallow water.

Never fertilize ponds with established weed problems. The fertilizer will only cause weeds to grow faster, making the problem worse. In ponds with shallow edges or excessive water discharge, fertilization cannot be expected to control or prevent establishment of aquatic weeds. Fertilizing in early spring before some types of rooted weeds begin to grow can be effective. In most cases, weed problems should be entirely eliminated before fertilizing. If in doubt on whether or not to fertilize, get professional advice.

## Common Fertilizers

Fertilizer Type	Grade	Pounds of fertilizer/Acre/ Application
Liquid	9-32-0	10 to 20
	10-34-0	10 to 20
	11-37-0	10 to 20
	13-38-0	10 to 20
Granular	20-20-5	40
	18-46-0	18
	8-8-8	100
	13-13-13	60
	0-46-0	18
	plus 34-0-0	plus 24

Figure 14. Fertilizer platform

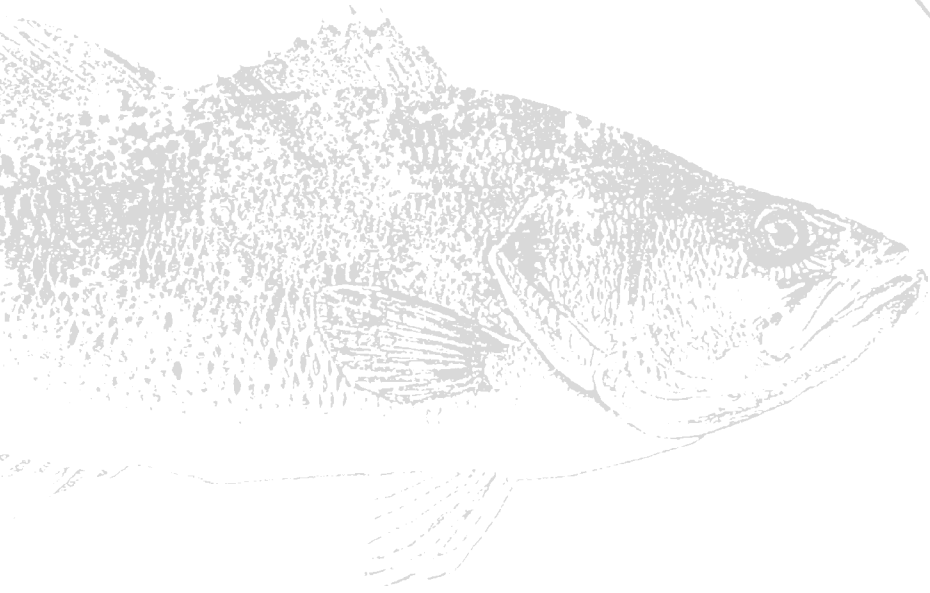
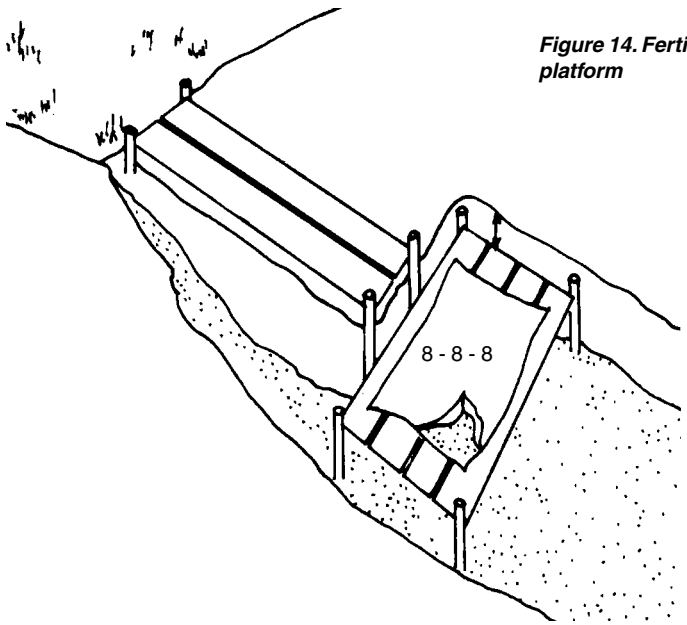



## LIMING PONDS

---

**Ponds with soft, acid water may not respond to fertilizer. If the water does not turn green after six weeks of fertilization, then liming may be necessary. Ponds with waters of less than 20 mg/l of total alkalinity normally need lime. The lower the alkalinity level, the better the pond will respond to liming. Applying agricultural limestone will increase water hardness and alkalinity and decrease acidity. This will make the fertilizer more effective.**

### Liming Materials

Agricultural limestone (calcium carbonate or dolomite), hydrated lime (calcium hydroxide) and quick lime (calcium hydroxide) are the most common liming materials for ponds. Agricultural limestone is not harmful to humans and will not cause high pH in water like the other forms of lime. It is the best and safest liming material to use in farm ponds.

### Soil Samples

A pond soil sample is needed to determine how much lime will be required. Collect samples from several locations evenly spaced across each pond, including both deep and shallow areas. Three to six samples per acre should be taken in ponds larger than 5 acres and at least 10 samples from smaller ponds. Samples can be collected easily in full ponds with a can attached to a pole. All individual samples should be mixed together and spread thin to dry. Dried soil samples should be pulverized, then placed in a soil testing box to

be sent for analysis. Only about 2 cups of mixed soil are necessary.

Chemical analysis of pond soils can be conducted at the LSU Agricultural Center Soil Testing Laboratory for a small fee. Soil samples should be delivered to the Louisiana Cooperative Extension Service office in your parish for processing. Be sure to indicate “Fish pond” on the soil information sheet. Test results and liming recommendations will be mailed directly to you.

### Application Methods

New ponds can be limed before they are filled. Spread the liming material evenly over the dry pond bottom. A disk harrow can be used to mix the lime into the soil. In ponds with water, limestone should be applied evenly across the water surface. In small ponds, this may be done by spreading bagged limestone from a boat. In larger ponds, where several tons may be required, a platform can be built on the front of a large boat or between two boats tied together. Bulk limestone can be loaded (do not overload!) on the platform and distributed across the pond surface with a shovel. Even distribution across the entire bottom is essential for good results.

Do not apply limestone while a pond is being fertilized. Limestone settles phosphorus out of the water, making it unavailable to phytoplankton. Apply lime during late fall and winter. This will give it a chance to react with the acidic bottom mud before the spring application of fertilizer.



## Frequency of Liming

A liming treatment may last almost indefinitely in ponds with no outflow. Most ponds have some water discharge or are drained and refilled periodically. Most ponds with acid soils and moderate water outflow will probably need lime every three to five years. A method frequently used with good results is to apply the amount of lime recommended by a soil test, then apply one-fourth of that amount each succeeding year to keep lime requirements satisfied.

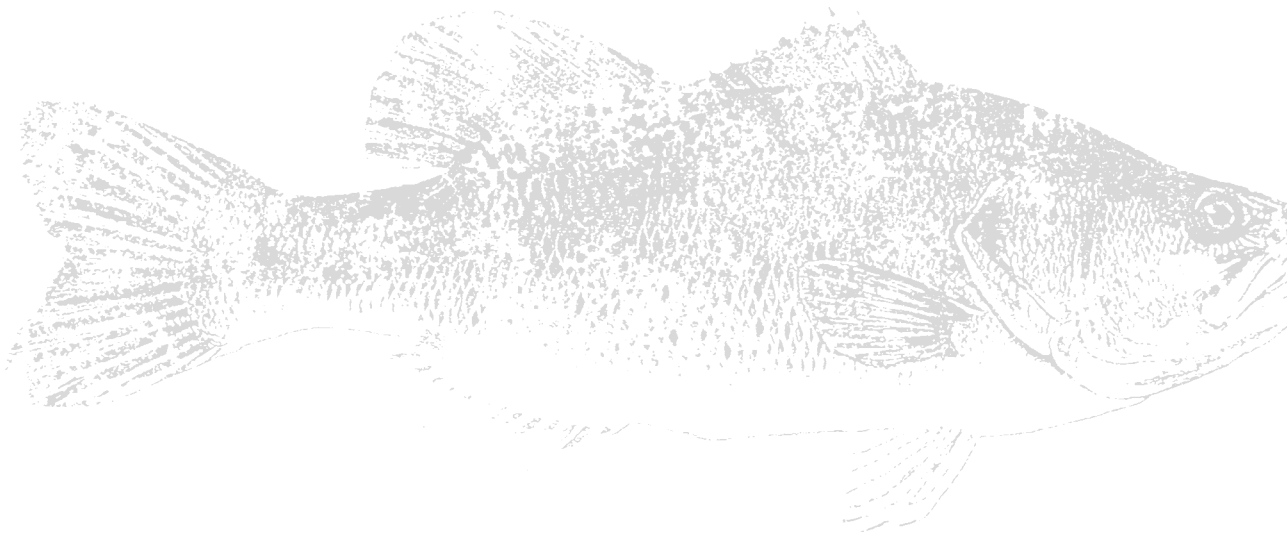



## SPECIES PROFILES FOR STOCKING

---

**When considering what fish to stock, determine your objectives in terms of food production, recreation, aesthetics or trophy angling and how much time you have to devote to pond management. Although many types of fish could be stocked into recreational ponds, few have the characteristics needed to provide quality fishing year after year.**

### **Bream**

The term bream refers generally to any of the sunfishes, including bluegill, redear, green sunfish, their hybrids and other species. Although their general appearance and food habits are similar, they can behave very differently in farm ponds, often with disappointing results. For this reason, it is important to properly identify bream being stocked into recreational ponds.

**Bluegill:** Bluegill are probably the best fish available to produce forage for bass, panfish for the dinner table and good light-tackle fishing. These fish are well-adapted to pond conditions and serve as a critical link in the food chain by consuming insects, snails, occasional plant material, small worms and microscopic animals while providing high-quality food for largemouth bass. They also provide most of the fishing in a well-managed pond. Bluegill normally live about five years if not caught or eaten by larger fish first. They can spawn at about 3 inches long and at one year of age. Bluegill should be stocked into new ponds in the fall and allowed to spawn before stocking bass fingerlings the next spring. The bluegill spawning season lasts from April-September in Louisiana, beginning when the water temperature reaches 70-75 degrees F. A quarter-pound female will lay approximately 12,000 eggs; very large females may lay up to as

many as 60,000. After spawning, the male bluegill guards the nest. In natural conditions, many nests are clustered together, called spawning beds. In Louisiana, mature bluegill can spawn as many as five times in a season.

Although bluegill provide an abundant source of forage to support bass populations, they will overpopulate and stunt if not tightly controlled through fishing and bass predation. An additional problem occurs when bluegill become so numerous that they interfere with bass spawning and reproduction. For this reason, pond owners should avoid excessive cover in bass-bluegill ponds, especially rooted aquatic vegetation.

The coppernose bluegill is a subspecies native to the Atlantic coast region from Florida to South Carolina. Mature coppernose have a distinct copper or cream-colored bar across the nose, extending back to the gill cover and often have a thin yellow or white margin on their fins. Immature coppernose have darker and more regular bars along their sides than common bluegill. Coppernose are aggressive feeders and may grow faster or larger than common bluegill, but they have not been conclusively demonstrated as a superior fish for stocking in Louisiana. (see Figure 15)

**Redear Sunfish:** This sunfish also produces a good forage base for bass production, but it produces the best results when stocked as a supplement to bluegill. When stocking a new pond, you can substitute approximately 20%-30% of the recommended bluegill with redear. To maximize survival, redear (or any other species) under 5 inches in length should not be stocked into existing bass-bream ponds.

Redear should be managed in the same manner as bluegill, but they will spawn earlier in the spring and normally spawn only twice in a season. Juvenile redear can usually be recognized by eight dark, often

broken, vertical bands on their sides. Although their food habits are similar, the redear sunfish focuses more attention on snails when they are available, and bluegill prefer insects. This feeding behavior has earned the redear the nickname “shell cracker.” (see Figure 16)

**Hybrid Bream:** Hybrid bream generally grow faster than pure bluegill or redear. Since they are aggressive feeders and usually accept pelleted food readily, hybrid bream are a good option if bream fishing is the objective, but they perform poorly as a sustained forage for bass production. Two common types of hybrid bream are produced: redear male x green sunfish female and green sunfish male x bluegill female crosses. Both crosses produce about 70% males, but some crosses, such as bluegill male x green sunfish female, produce almost 100% males.

Hybrid bream are usually fertile, although they may not spawn reliably. When they occur, offspring of hybrids or their backcrosses to parent species are generally mongrels that cannot support fishing or bass predation for more than a year or two. For this reason, draining or renovation is often required every three to four years in ponds with hybrid bream.

**Green Sunfish:** This sunfish species is generally regarded as a trash fish. Every effort should be made to inspect bluegill or redear fingerlings to be sure they are not contaminated with green sunfish. For the same reasons, assorted or wild bream are not recommended for pond stocking. The dark spot normally found at the rear of the dorsal fin in bluegills is faint or absent in green sunfish juveniles, which tend to have a darker background color.

Green sunfish tend to overpopulate and stunt at extremely small sizes, and almost always reach densities which completely prevent bass reproduction. At this point, pond owners have few options other than to drain or poison the entire fish population and restock. Green sunfish are particularly hardy fish and sometimes difficult to kill. Even when ponds are drained, eggs of this species may survive in puddles or moist soil. (see Figure 17)

## Bass

**Largemouth Bass:** The largemouth bass is the top-level predator in most recreational ponds and many natural habitats in Louisiana. This fish is widely sought both for sport and as food. As a result, it is often stocked in ponds too small to support self-sustaining populations adequately. The largemouth bass adapts well to ponds of one acre and

larger. It uses a variety of foods including fish, crawfish, insects, frogs, ducklings, rodents and other animals.

Largemouth bass can spawn successfully in most ponds and grow rapidly if sufficient food and space are available. In Louisiana, they can reach sexual maturity at one year of age. Nesting on hard substrates, sand or gravel usually begins in the spring when water temperatures reach 60 to 65 degrees F. Mature females produce from 2,000 to 7,000 eggs per pound of body weight, which the male guards during the 2- to 4-day incubation period after spawning.

Stocked alone without some forage species, largemouths usually stunt and reproduce poorly. They require other fish, such as bluegill, as food to allow for good growth and spawning. Largemouth bass should generally be stocked in late spring, the year after bream have been stocked, so adequate forage will be available to support survival and growth. In most areas, largemouth bass normally live about six to eight years if not caught by fishermen or eaten by larger fish.

Florida-strain largemouth bass have become widely sought after in recent years because of their faster growth rate and larger maximum size than native populations of largemouth. Although they often attain trophy sizes in large ponds and reservoirs, these fish may not perform as well in ponds less than three acres, or where fast-moving cold fronts can drop temperature suddenly. (see Figure 18)

## Catfish

**Channel Catfish:** This hardy fish grows fast and readily takes artificial food in a pond environment. Channel catfish often have difficulty reproducing if bass or bream are present in the same pond because of the extreme vulnerability of their fry to predation. This species feeds primarily on invertebrates, such as insects and crawfish, as well as on fish and frogs. In recreational ponds, channel catfish will eat a wide variety of foods, including plants and decaying organic matter. Channel catfish are generally stocked into ponds in fall before stocking bass the next spring, but they can be stocked at almost any time in catfish-only ponds.

Channel catfish normally live six to eight years. If suitable spawning areas are present, such as large pipes, cans or boxes, they will spawn readily in ponds. If bass and/or bream are present, almost all eggs and fry will be consumed, and catfish reproduction can be encouraged. If stocked alone, catfish will tend to overpopulate and stunt, so spawning should be discouraged. When stocking channel catfish in established bass-bream ponds, use those more than 10 inches long. (see Figure 19)

**Blue Catfish:** This species is similar to the channel catfish, although not quite as hardy. In ponds, their diet is similar to that of channel catfish, but they prefer to feed primarily on fish, such as bream. For this reason, they may be preferable in some situations where bream tend to overpopulate. Blue catfish also tend to grow somewhat larger than channels after the second year of life. Unfortunately, it is usually much harder to find blue catfish fingerlings. Blue catfish fingerlings can be distinguished from channel catfish fingerlings by the absence of spots. They also have smaller, lower-set eyes. In general, the same stocking and management recommendations apply for both species. (see Figure 20)

### Forage Species

Golden shiners are sometimes stocked as a supplement to bluegills for bass forage in alkaline waters or areas of high rainfall. Fathead minnows (1000/acre) or threadfin shad can be stocked into farm ponds to help establish first-year bass populations.

### Fish to Avoid

**Crappie:** (white perch, sac-a-lait, flathead catfish (Opelousas or yellow cat), green sunfish, bullheads (mudcats), carp, buffalo or other rough fish should never be stocked into recreational fishing ponds. All will eventually overpopulate and ruin fishing. Crappie, also known as white perch or sac-a-lait, should never be stocked into recreational ponds smaller than 10 acres because they will overpopulate and stunt, eventually preventing bass reproduction. Even in large ponds of 10 acres or more, they require careful

management to prevent problems. Avoid stocking wild fish or fish caught from other waters; they can introduce diseases to your pond.

## Recommended Stocking Combinations

### Bream-Bass-Catfish Combinations (Fish per Acre):

For 1 Acre or Larger Ponds

	Bream	Bass	Catfish
	Bluegill	Redear	
	1000	100	100 (fertilized)
or	700	300	100 (fertilized)
or	500	50	50 (unfertilized)
or	350	150	50 (unfertilized)

Bream (1- to 3-inch) should be stocked in the fall with bass (1- to 3-inch) stocked the following spring. If both species must be stocked in the spring, stock 20 6-inch bass and 30 3-inch or larger bream per acre. Double these rates for fertilized ponds. Catfish can be stocked in the fall or spring in new ponds, but they should be at least as large as any bass fingerlings present. Supplemental stocking of catfish into existing bass-bream ponds should use 10-inch fish (or larger) at a rate of 25 per acre in unfertilized ponds or 50 per acre in fertilized ponds. As catfish reach three years of age and 3+ pounds, reproduction can be encouraged by providing cans, tires or other shelters for spring spawning.

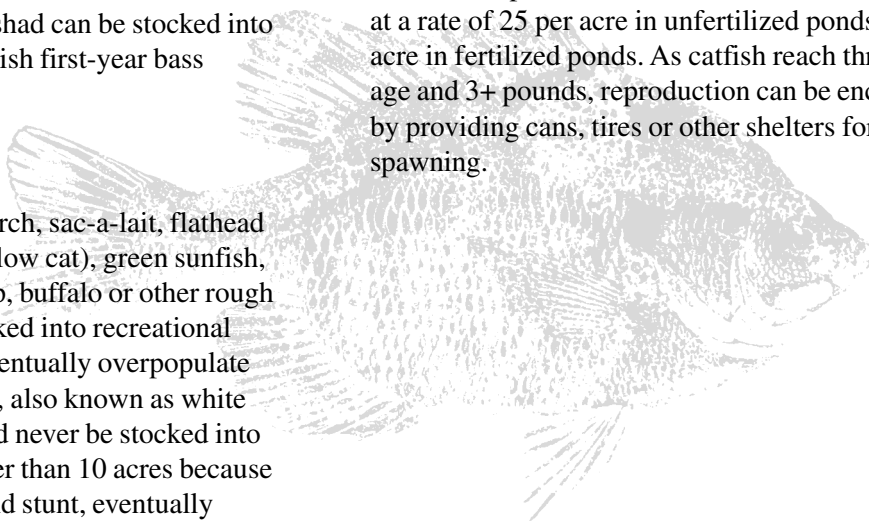

---



---

### Bream-Bass Combinations (Fish per Acre):

For 1 Acre or Larger Ponds

---

	Bream		Bass
	Bluegill	Redear	
	1000		100 (fertilized)
or	700	300	100 (fertilized)
or	500		50 (unfertilized)
or	350	150	50 (unfertilized)

---

Again, 1- to 3-inch bream are stocked in the fall with 1- to 3-inch bass stocked the following spring. Advanced fingerlings may be stocked together in the spring as described above.

---



---

### Catfish-only Stocking:

Especially Recommended for Ponds Under 1 Acre

100-200 fish per unfertilized acre,  
 200-400 fish per fertilized acre,  
 300-600 fish per acre when fed daily

---



---



---



---

### Catfish-Hybrid Bream Combinations (Fish per Acre):

Especially Recommended for Ponds Under 1 Acre

---

Hybrid Bream	Catfish
150	50 (unfertilized)
300	100 (fertilized)
600	200 (fed daily)

---

Catfish reproduction should not be encouraged with catfish-only or catfish-hybrid bream stocking. Do not provide cans, tires or other shelters for spawning. Restock with catfish when most of the original stock has been removed.

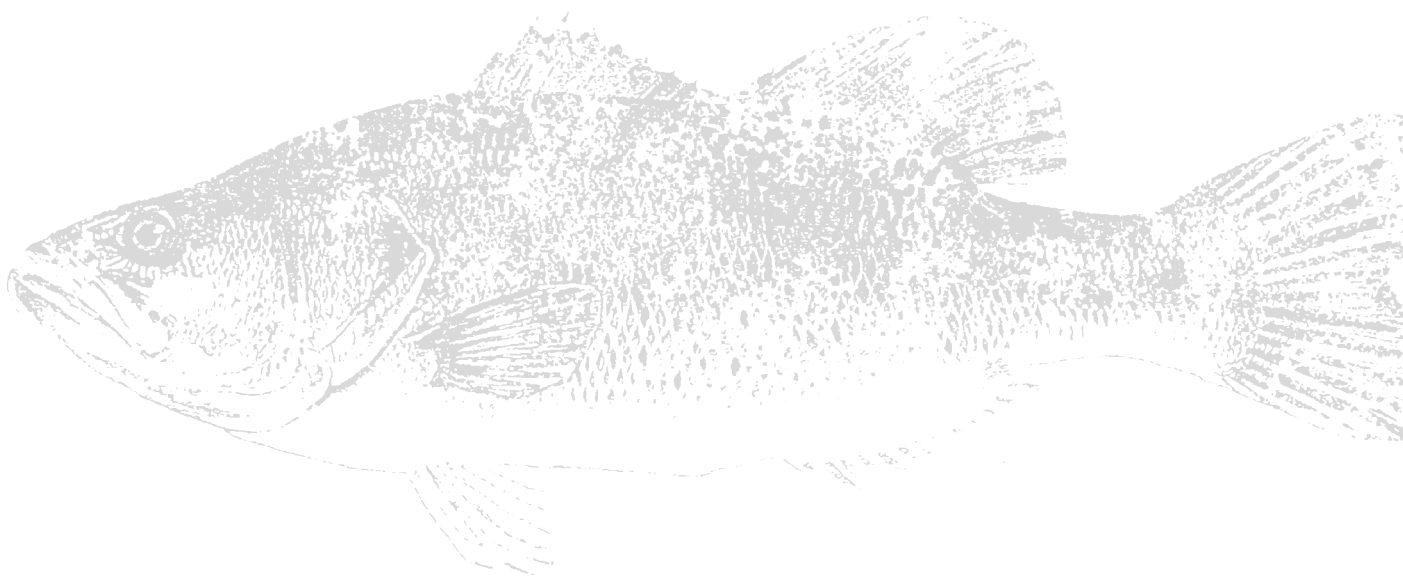
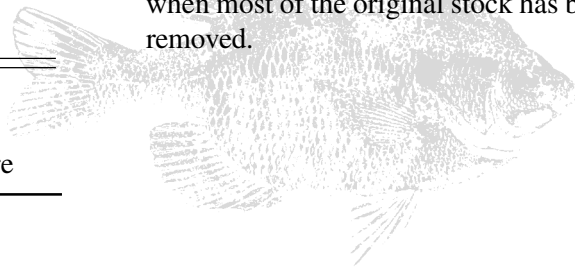

*Figure 15. Bluegill*

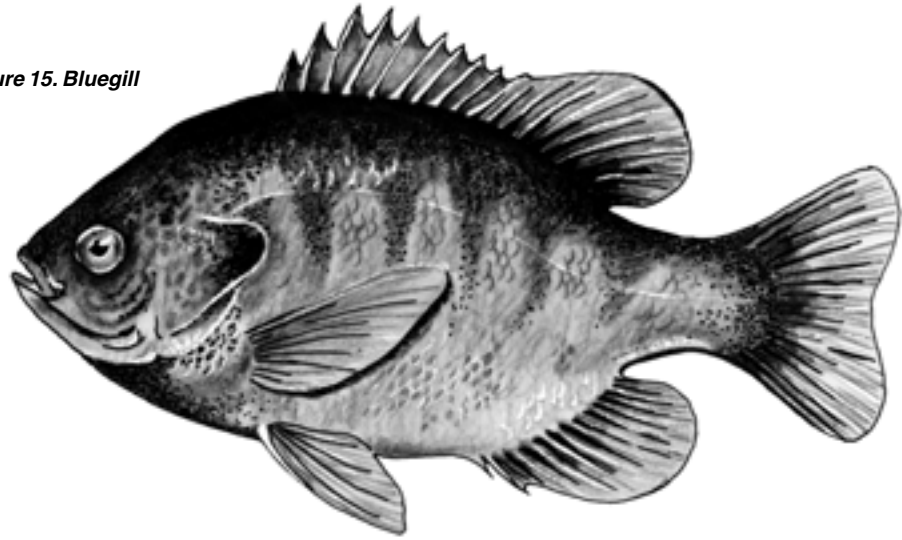

*Figure 16. Redear Sunfish*

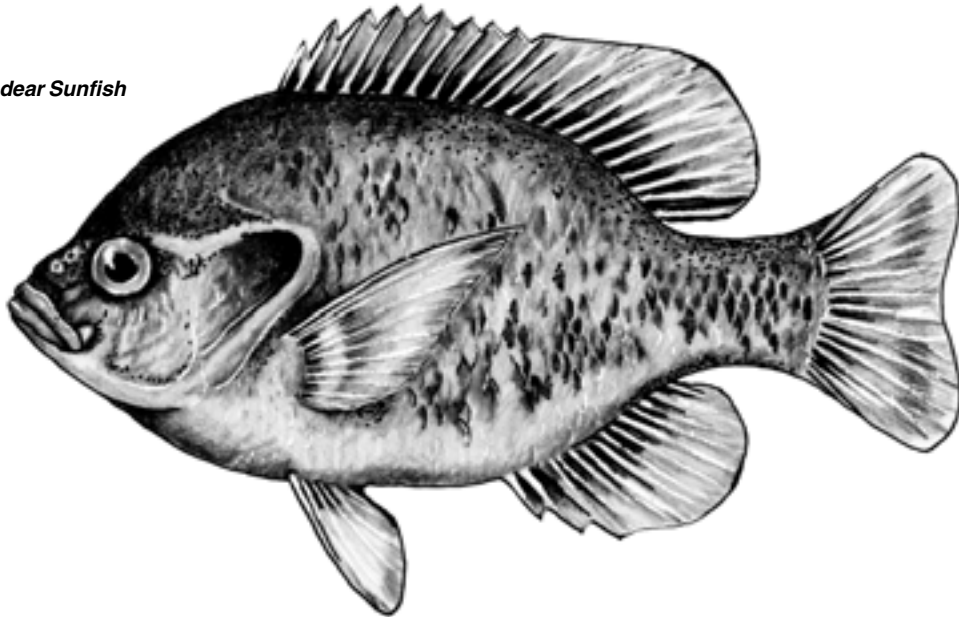

*Figure 17. Green Sunfish*

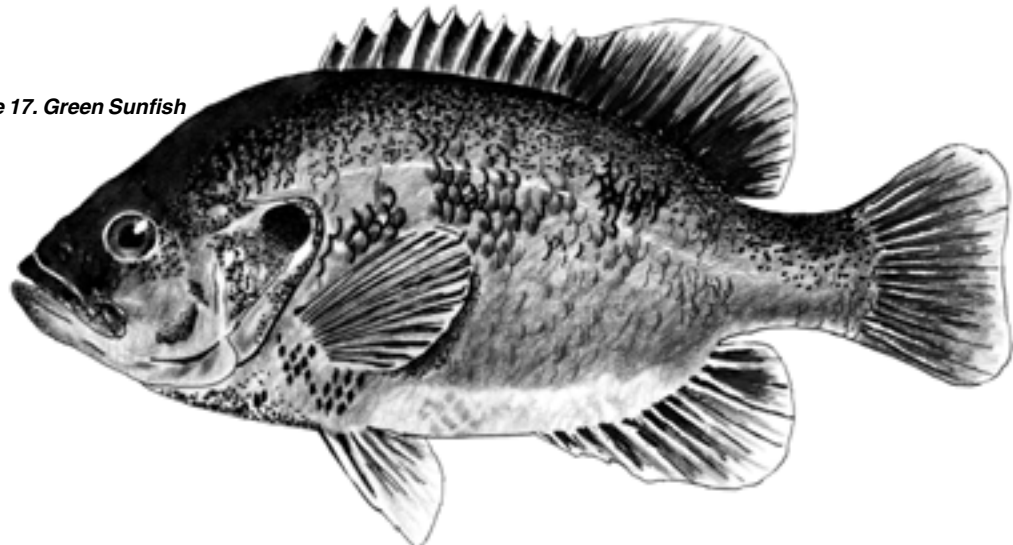

*Figure 18. Bass*

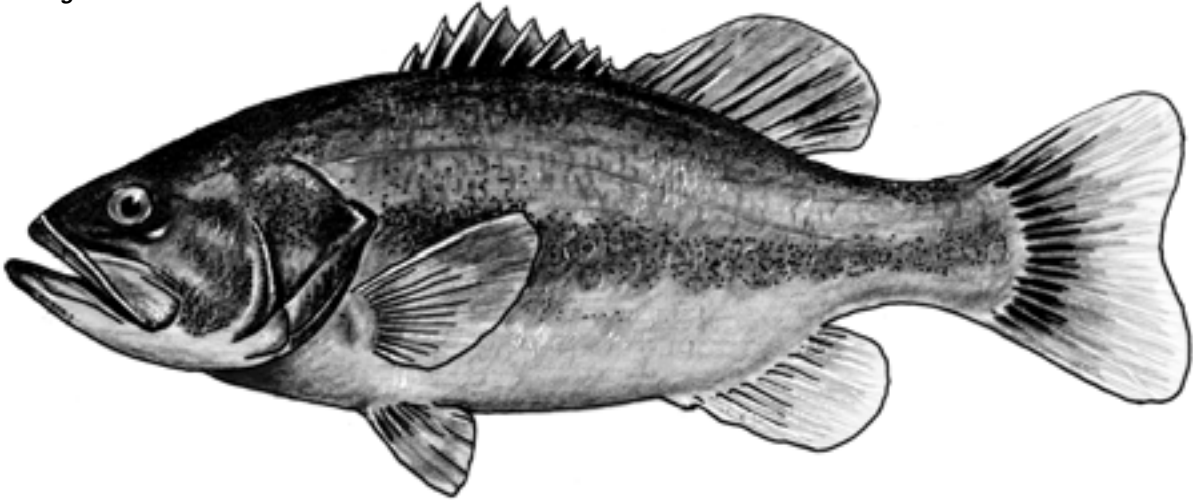

*Figure 19. Channel Catfish*

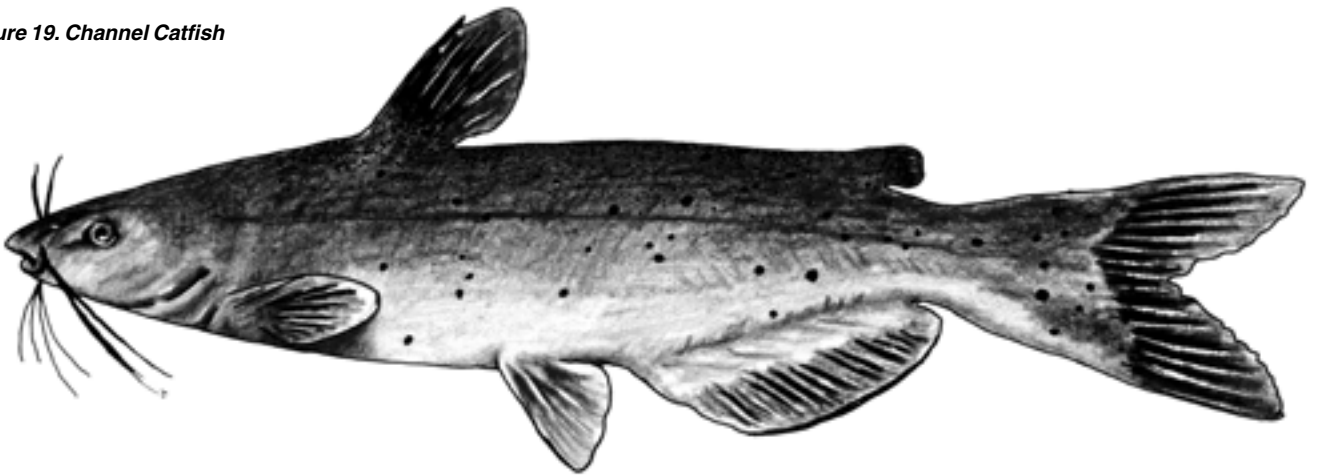

*Figure 20. Blue Catfish*

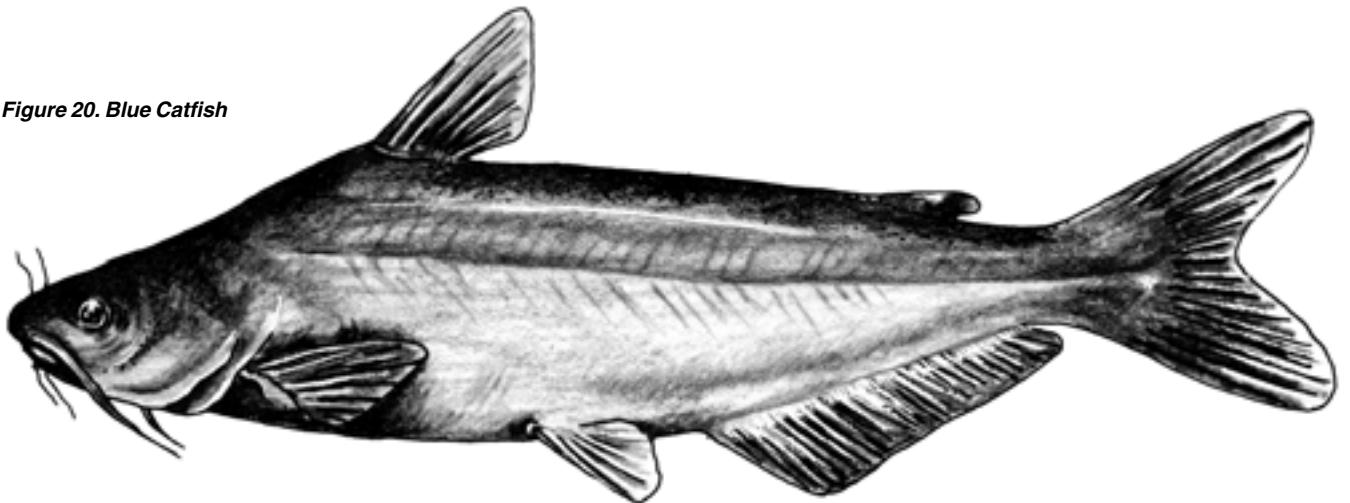



## STOCKING PROCEDURES

---

**Once the decision has been made as to what to stock, it is important to follow the proper procedures to maximize the health and survival of the fingerlings purchased. If survival of one or another type of fish being stocked is low, actual numbers will differ greatly from the recommended rates, and pond balance may be difficult to establish or maintain. In some instances, high mortality shortly after stocking may go unnoticed. For this reason, every effort must be made to minimize stress during transport and stocking.**

### **Acclimation Procedures**

Fingerlings for stocking are generally transported in hauling tanks with aeration or in sealed bags with oxygen. Upon arrival, gradually replace water in hauling tanks with water from the pond to be stocked. This can be done with a small pump or with buckets. Adjust temperature gradually, with no more than a 7-8 degree F increase or a 5 degree F decrease per half hour. Continue aeration during this process. When temperatures have been adjusted, transfer fish to the pond as gently as possible, with minimal handling.

If fingerlings arrive in sealed plastic bags, float the bags in a shady area for 30 minutes, then open them and immediately release the fish. Normally, pond water should not be gradually mixed with shipping water in bags. Carbon dioxide and ammonia build up in shipping bags during transport. Since these compounds cannot dissipate into the atmosphere, dissolved carbon dioxide reaches very high levels, lowering the pH of the shipping water. Opening the bags allows the carbon dioxide to escape rapidly, and aerating or splashing accelerates this process. The pH rises drastically, and any ammonia present rapidly converts to the toxic form. This chain of events will kill fry and small fingerlings quickly.

This problem is less serious when transport times are short and when fish have not been fed for several days. Gradual mixing of pond water with transport water in bags (after temperature adjustment) is usually desirable only when moving young fish from hard water to moderately or very soft water. When attempting this procedure, monitor the fish closely for signs of stress, and introduce them directly into the pond if they begin to appear weak or disoriented.







## OXYGEN DEPLETIONS AND OTHER TYPES OF FISH KILLS

---

**Although exposure to agricultural chemicals can occasionally result in direct fish mortality, most fish kills in recreational and farm ponds are the result of oxygen depletions. Dissolved oxygen levels depend on temperature, pond depth, productivity and fertility, and water movement. In almost any aquatic environment, fluctuations in natural nutrient cycles can create imbalances which lead to oxygen depletions and fish kills. Generally, these fluctuations are difficult or impossible to predict, but high nutrient levels from feeding or over-fertilizing almost always compound problems with oxygen management.**

**As nutrients accumulate in the pond system, some end up directly in the bottom mud but most go into solution in the water column first, where they are used by plants and animals. The most abundant plants in a well-managed fishing pond are found in the algal bloom, which gives the pond water a greenish tint. Suspended in the water, these microscopic single-celled plants are sometimes referred to as phytoplankton. Except for situations where excessive vegetation is present, most nutrients dissolved in the water are taken up by the algal bloom.**

### **Algal Blooms and Oxygen**

Like all green plants, phytoplankton produce oxygen during the daylight hours as a by-product of photosynthesis. This is usually a major source of oxygen in fish ponds. In darkness, however, all plants consume oxygen, including phytoplankton. Blooms in natural water bodies or fish ponds normally produce much more oxygen in the daylight than they consume during the night, but some situations reduce the amount of oxygen a bloom produces without reducing its nighttime oxygen consumption.

Trace minerals or nutrients needed by the algal bloom are occasionally used up. This usually results in some, or occasionally all, of the phytoplankton dying back temporarily. This is probably the most common cause of phytoplankton dieoffs, especially for heavy blooms with competition for light and nutrients. When a large portion of the bloom dies off at once, bacterial decomposition and the loss of normal oxygen production can lead to oxygen depletions and fish kills. Pond water generally changes from a deep green to black, gray, brown or clear after a phytoplankton dieoff.

Blooms respond to changes in the weather. Photosynthesis slows down under cloudy conditions, and, as a result, oxygen production decreases. Extremely calm days may also reduce photosynthesis and oxygen production, even under sunny conditions, by preventing phytoplankton in the middle layers of the pond from mixing near the brighter surface. In summer, oxygen problems may arise because of a simple physical property of water. The warmer the water, the less dissolved oxygen it can hold. When a dense bloom produces a surplus of oxygen on a summer afternoon, the oxygen will not stay in solution and escapes into the atmosphere. During the night, the bloom attempts to take more oxygen out of the water than what remains from daytime photosynthesis. When this occurs, dissolved oxygen levels approach zero. Fish begin to suffocate in the pond, and aeration must be applied to meet the demand for oxygen and prevent fish losses.

Many ponds also experience oxygen problems in early spring. As the water warms and the amount of sunlight increases, algal species which predominated in the bloom during the winter die back, and other species more suited to summer conditions multiply and replace them. When this process proceeds gradually, conditions remain

fairly stable. Occasionally, however, the winter bloom dies off abruptly and insufficient oxygen levels may occur for several days.

This type of oxygen depletion may kill some fish directly or cause sufficient stress to weaken their immune systems. Bacterial infections usually occur within the next several days to two weeks. Various signs, such as color and odor changes or a buildup of foam on the downwind bank, can sometimes be useful in anticipating when a winter bloom will die back.

## Other Algal Bloom Impacts

Other problems are associated with dense algal blooms. In low-alkalinity waters, dense algal blooms create wide fluctuations in pH daily. Occasionally, heavy phytoplankton populations cause pH to reach extreme values in the afternoon. Algal die-offs can also result in high ammonia concentrations. Both processes affect fish health, growth and survival adversely. An additional problem caused by dense blooms, especially in excessively deep ponds, is stratification. As mentioned earlier, stratification involves layering of the pond water into warm, oxygen-producing upper zones and cool, oxygen-consuming bottom waters. Shading caused by dense blooms limits photosynthesis and dissolved oxygen levels at the pond bottom, resulting in a buildup of potentially toxic compounds, even in aerated ponds.

This situation can lead to physiological stress, reduced fish growth and even fish kills if bottom waters are mixed too rapidly with the rest of the pond. This type of mixing, referred to as a turnover, occurs when cool rain water or heavy wind on the pond surface breaks down layering patterns. Turnovers are often observed in natural waters and ponds in the fall or spring after severe weather disturbances. The potential for a turnover can be detected by an increasing temperature difference between a pond's bottom layers and its surface waters. If a turnover is likely, prepare for aeration when necessary.

## Response Options - Aeration

Once under way, oxygen depletions are fairly easy to recognize. Partial depletions can be recognized by fish hanging at the water surface during the early morning hours or a loss of appetite in ponds where fish are fed. Lethal oxygen

depletions begin with similar symptoms. Fish congregate at the pond surface, gulping air. During the early minutes of the depletion, they may dive when disturbed and return to the surface. As conditions worsen, they will ignore most disturbances and continue gulping air.

Mechanical aeration is required to raise oxygen levels once a depletion has begun. Irrigation or industrial pumps can be used to pull water from a depth of 2 to 3 feet and spray it back into the pond. Successful alternatives to agitate pond water mechanically have included outboard motors, bush hogs and other devices. A bush hog can be backed into the pond to a point where the blades just touch the water. An outboard motor operating in a fixed tilted position (keep boat tied up or pointed into the shore) with the propeller wash directed out into the pond can also provide effective aeration in emergency situations.

Flushing with clean, aerated water will help improve water quality, but this alternative is not available for ponds which depend on runoff as a water source. Emergency aeration will be most effective in smaller ponds, and the success of any aeration practice will depend on the severity of oxygen depletion.

## Fish Kills from Chemical Contamination

Fish kills resulting from chemical contamination generally take one of two forms: direct poisoning of the fish or oxygen depletion resulting from poisoning of the algal bloom. Application of agricultural chemicals to croplands which run off into the pond must be practiced with great caution. Direct poisoning may be involved if small fish die before larger fish of the same species. If direct poisoning of fish or phytoplankton is suspected, contact the local Extension office and the Louisiana Department of Agriculture and Forestry immediately.



# DISEASES IN POND FISHES

---

## The Role of Stress

**Fish disease organisms are constantly present in most aquatic environments, and farm and recreational ponds are no exception. Under optimum conditions, healthy fish are able to fight off most forms of infectious diseases. Conversely, fish subjected to stress are often unable to maintain their natural defenses against infectious diseases such as bacteria, viruses, fungi or protozoan parasites.**

Stress may result from a variety of conditions, including overcrowding, handling stress, poor water quality, inadequate nutrition and weather-related environmental stress. These forms of stress may kill fish outright, in which case they can be considered non-infectious diseases. More often, however, they do not kill fish outright but lead to outbreaks of infectious diseases. Ironically, a common cause of stress is chemical toxicity from disease or weed control efforts. In summary, three factors are involved in fish disease outbreaks: infectious pathogens (viruses, bacteria, fungi or protozoan parasites) must be present and capable of attacking the fish, the fish must already be in a susceptible state, and certain environmental conditions, such as specific temperatures or poor water quality, must be present. (see Figure 21)

As mentioned, many fish disease-causing organisms are usually present in ponds, and little can be done to eliminate them or prevent them from recurring. These organisms alone, however, are usually not enough to cause disease problems. For this reason, disease problems will usually reoccur in fish ponds unless the conditions which caused the initial fish stress can be identified and eliminated. Three main practices can minimize the possibility of disease outbreaks. These are maintenance of good

water quality, proper nutrition and elimination of contact with wild fish whenever possible. A sound fertilization program can contribute to the first two objectives. The third can be achieved through proper pond design and water management, as well as prevention of fish introductions outside of the established stocking plan.

Common water quality stressors are low dissolved oxygen and/or a buildup of toxic nitrogenous compounds, especially ammonia and nitrite. Dissolved oxygen problems are most common in the early spring and the mid-to-late summer. Nitrogenous compounds are more of a problem in cold water during the winter.

## What to Look For

Fish should be observed every day, if possible, or as often as practical. The following signs should be noted immediately: reduced feeding, scratching or rubbing against submerged objects and/or the pond bottom, piping or gasping at the water surface, convulsions or erratic motion, abnormal swimming (spinning or spiraling), blisters or sores, swollen bellies, listlessness, bulging eyes, bloody or bruised fins, discoloration or erosion of fins and skin, excessive mucus, puffy or bleeding gills and growths or spots on the body surface.

## What to Do

Rates of mortality should be carefully recorded and monitored over time to help determine the cause of the problem. Your county agent can assist in obtaining a disease diagnosis and treatment recommendation if disease problems

develop. The sooner a diagnosis is obtained, the sooner corrective measures can eliminate the cause of the outbreak. Although direct treatment of certain diseases may be possible in recreational ponds, these options are limited to situations where fish such as catfish or bream can be fed medicated pellets or where external parasites can be treated without further stress on the fish population. Do not attempt disease treatment without a professional diagnosis and treatment recommendation. Indiscriminate use of chemicals or medications almost always wastes money, time and fish.

### Internal Parasites

Many ponds produce fish with worms or cysts in the flesh. Perhaps the most common of these organisms is the yellow grub, although the white, black and eye grubs are also widely found in pond fish. All these parasites have similar life

cycles, based on intermediate hosts such as snails and birds. Although these grubs are not harmful to humans eating the fish, they are unappetizing and result in physiologic stress to fish.

To control these parasites, their life cycle must be broken. Perhaps the easiest way to achieve this with the yellow grub is to eliminate snails, which serve as intermediate hosts. Pond owners should avoid introducing snails and infected fish during stocking. If snails become established, vegetation control will limit their available food and cover. Perhaps the best approach to snail control is stocking of redear sunfish, which will further reduce snail populations. If these measures fail to control the problem within an acceptable period, it may be necessary to drain and dry the pond to eradicate these parasites.

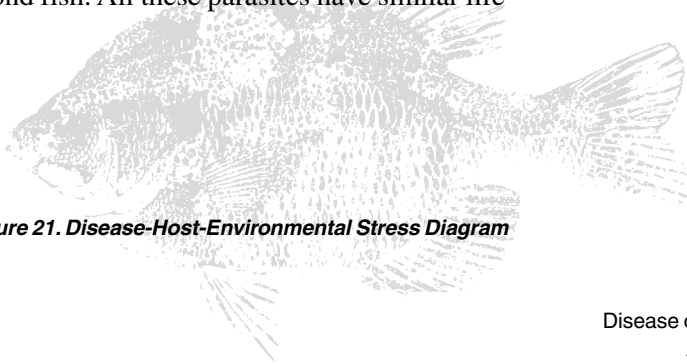
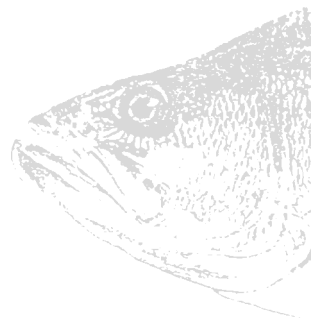
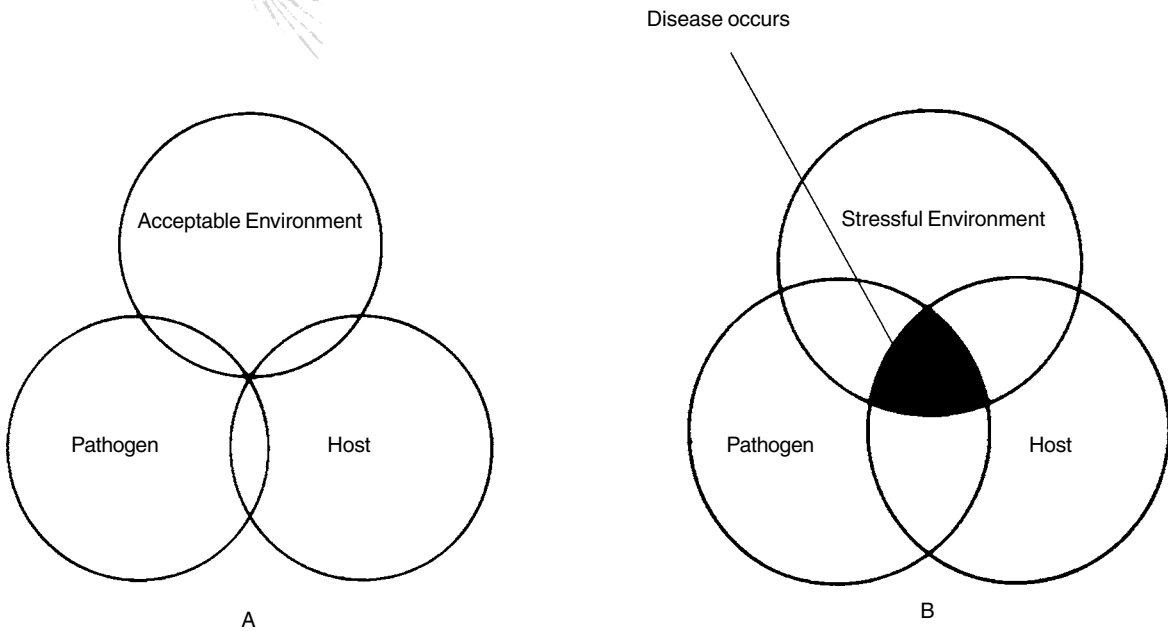

Figure 21. Disease-Host-Environmental Stress Diagram





## MANAGING BASS AND BREAM POPULATIONS

---

**Management of bass and bream populations requires maintaining a balance in the predator-prey relationship of these two species. Sustained fishing success will not be possible without careful attention to the number, size and condition of bass and bream being caught. For this reason, harvest records are essential in the management of ponds stocked with bass and bream.**

In Louisiana, bass stocked as fingerlings should be allowed to remain in the pond until the second summer after stocking. In most cases, no more than 30 to 35 pounds of bass per acre per year can be removed from a fertilized pond if balanced populations are to be maintained. This limit is reduced to 15-20 pounds in unfertilized ponds.

Whether you keep track of numbers or pounds of fish, most of the fish harvested from a bass-bream pond should be bream. A general recommendation is to harvest at least 5 pounds and as much as 10 pounds of bream for every pound of bass. In many instances, any bluegill which is caught should be removed from the pond, whether it is large enough to eat or not. Redear sunfish are not as prolific as bluegill, and may be thrown back except when bream populations are extremely high.

Another point to remember is that when a bream is removed from the pond, another individual will grow to take its place within several months. When a bass is caught, however, it will take roughly one year for a younger fish to take its place. For this reason, bass harvests must be spread out over the entire fishing season if pond balance is to be maintained.

If both bass and bream exhibit good reproduction, a pond can probably be considered in balance. One way to ascertain spawning success is to sample shallow areas from mid-May to late June with a small-mesh minnow seine, approximately 15 to 30 feet in length and 4 to 6 feet deep. Ideally, various sizes of both species will be present, including young-of-the-year in the 1- to 2-inch size range. The late Dr. H.S. Swingle of Auburn University developed the following method of evaluating pond balance based on seining samples: (see page 38)

Another way to determine whether bass and bream populations are in balance is to evaluate the size of fish being harvested. If most of the bream are small (less than 5 inches long) and few small bass are present, the pond is probably overpopulated with bream. This is common. On the other hand, if only a few very large bream are present and many small bass are in the pond, additional bass harvests may be necessary.

The percentage size distribution (PSD) method of evaluating pond balance is useful if good records are available for the pond. Records should be kept of all largemouth bass larger than 8 inches caught from the pond. Of those bass, any fish larger than 12 inches can be considered a "quality" fish. The PSD for the bass population is determined by the percentage of all bass over 8 inches long which can be considered quality bass (over 12 inches.) If 10 fish over 8 inches in length are caught and six are over 12 inches, the PSD is 60. Balanced bass populations generally have PSD values between 20 and 60.

---

---

**Fish Collected by Seine****Condition of Population****Recommendation**

---

No young bass. Many recently hatched bream and few or no 3- to 5- inch bream.

Bass slightly crowded.

Harvest more bass.

No young bass. No recently hatched bream but many 3- to 5- inch bream.

Bream overcrowded.

Remove excess 3- to 5- inch bream. Correct problems such as excess vegetation or turbidity. Bass stocking may be desirable.

No young bass. No recently hatched bream. Many 3- to 5- inch bream and many tadpoles, minnows or crawfish.

Bream overcrowded.

Same as above, but bass should be stocked at 50 per acre the next spring.

No young bass. No recently hatched bream and few or no 3- to 5- inch bream.

Other types of fish competing with bream.

Undesirable fish must be eliminated by draining or renovating. Restock as new pond.

Same as above but with many 3- to 5- inch green sunfish.

Green sunfish competing with desirable bream such as bluegill and redear.

Same as above, or reduce green sunfish by intensively seining accessible areas.

Young bass present. Many recently hatched bream. Few 3- to 5- inch bream.

Balanced population.

No action required.

Young bass present No recently hatched bream No 3- to 5- inch bream.

Bass overcrowded.

Stock bluegill and/or redear adults (4- to 6- inch fish) at up to 200 fish per acre.

Young bass present. No recently hatched bream. Few 3- to 5- inch bream.

Other species may be competing with bream.

Monitor situation to determine if removal or eradication of competing species is required.

---

---

For bluegill, quality fish are considered to be 6 inches or longer, with any fish over 3 inches included in the PSD calculation. If 10 fish over 3 inches long are caught and two are over 6 inches, the estimated PSD is 20.

### Management Recommendations for Various PSD Values

Bass PSD	Bream PSD	Recommendation
More than 60	Less than 50	Increase bluegill harvest. Return all bass.
20 to 60	Less than 50	Increase bluegill harvest. Return large bass.
Less than 20	50 to 80	Harvest more small bass.
Less than 20	More than 80	Harvest more small bass. Return large bluegills.
20 to 60	50 to 80	Balanced. Return large bass.

These PSD recommendations apply to general situations. Individual ponds vary widely in their ability to support different ratios of bass to bream, so use PSD values as indicators rather than management goals. Several years of diligent management may be required to bring bass and bream populations back into balance. Occasionally, however, ponds may go so far out of balance that more drastic corrective measures are needed, as described in the next section.

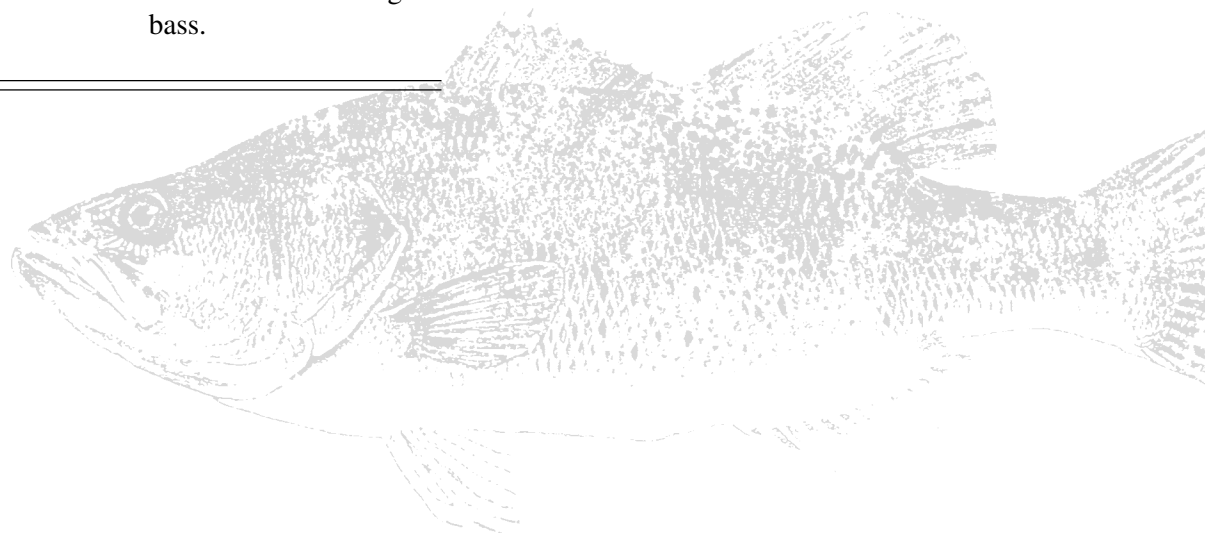



## RENOVATION OF PONDS

---

Sooner or later, many ponds become contaminated with undesirable species such as crappie or green sunfish. Alternately, ponds may go so far out of balance that only stunted bream populations remain. In this situation ponds may have to be drained and dried and a new stocking program established. When draining is not possible or too costly, an acceptable alternative may be to kill all fish present with rotenone, a natural compound which kills fish by interfering with their respiration. This practice is known as renovation. When the fish population and previous history of a pond are unknown, as when an old pond has recently been purchased, one of the simplest and most reliable management approaches is to renovate and restock.

Since treatment is most effective during warm weather and recommended schedules call for fall stocking of bream, August or early September is the best time to renovate ponds in Louisiana. This should allow for sufficient detoxification before restocking bream in the fall, even if repeat treatments are needed.

### Determining Pond Volume

The first step in effectively poisoning the existing fish population is to determine the volume of water to be treated. Rotenone and other chemicals are applied based on the “acre-feet” of water present in a pond. To determine the acre-feet, multiply the surface area of the pond by the average depth.

If the average depth is not known, take readings at 10- to 20-foot intervals across the length and the width of the pond. The average depth will equal the total of all the depth readings added together divided by the number of readings taken. (see Figure 22)

The surface area of a circular pond can be determined by multiplying the circumference (in feet) times itself and then dividing the result by 547,390. For rectangular ponds, multiply the length times the width (both in feet) and divide the result by 43,560. For triangular ponds, multiply the length times the width (both in feet) and divide the result by 87,120. (see Figure 23)

### Application Rates and Procedures

Although published recommendations may vary, a rate of 1 gallon of liquid rotenone or 10 pounds of 5% powdered rotenone per acre-foot of water is usually sufficient for eradication of bream. If bullheads, green sunfish, gar or bowfin (choupique or grinnel) are present, two to three times this amount may be required for effective control. Repeat treatments may be required for green sunfish problems. For good results, apply rotenone when water temperatures are higher than 70 degrees F. Renovation using rotenone is usually unsuccessful at lower temperatures.

Liquid rotenone should be mixed with water at a 1:5 ratio; powdered rotenone should be mixed with water to a milky consistency, then diluted at the same 1:5 ratio. For large ponds, you can pour the rotenone solution into the prop wash of a boat while slowly crisscrossing the pond. Smaller ponds may be treated from the shore by spraying the solution along the upwind bank.

It is essential to treat all areas and depths of the pond, especially shallow, vegetated areas. Deep areas may have to be specially treated using weighted hoses or downspout pipes to ensure coverage. Avoid stirring up too much mud, however, since this will reduce the effectiveness of the treatment. When ponds can be only partially drained, remaining pools and puddles can be treated with rotenone.



## Restrictions

A pesticide applicator's card is required to purchase and apply rotenone. Additionally, the FDA has not approved fish killed with rotenone for consumption by humans or animals. Although rotenone-treated water is safe for livestock, 10 to 14 days are usually required for rotenone to break down or detoxify. During this period, no water should be released into streams or other public waters. After 10 to 12 days, several goldfish or small bluegill can be placed in a minnow bucket in the pond. If these fish survive for one or two days, it is generally safe to begin restocking the pond.

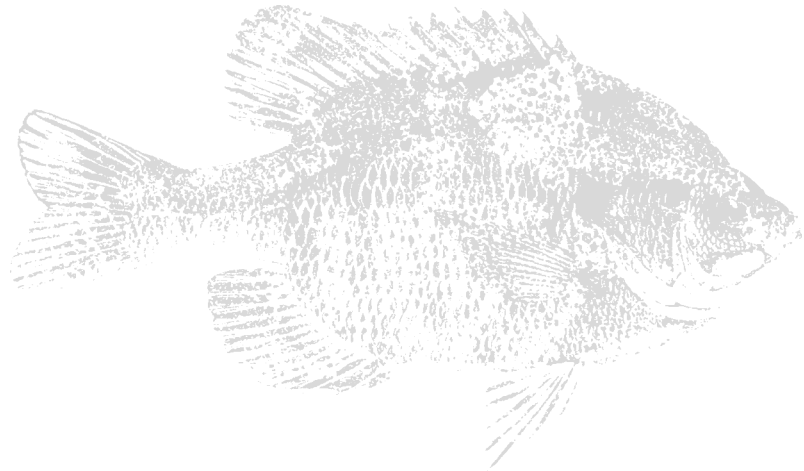
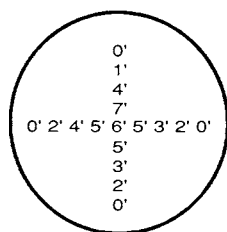
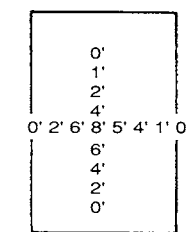

Figure 22. Determining Average Depth



Number of Readings  
Total of Readings  
Average Depth



17  
49  
 $\frac{17}{49}$   
2.9 feet

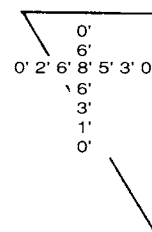

16  
45  
 $\frac{16}{45}$   
2.8 feet

13  
39  
 $\frac{13}{39}$   
3 feet

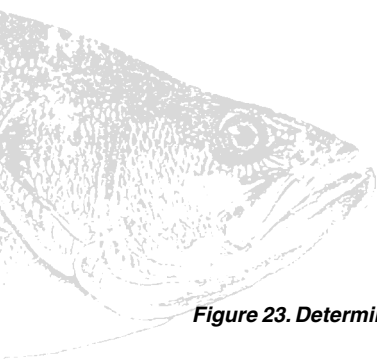
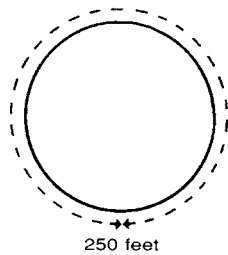
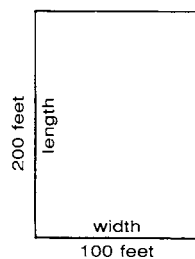

Figure 23. Determining Surface Area and Acre-feet



Example 1.

$$\begin{array}{r} \text{shoreline length} \times \text{shoreline length} \times \text{average depth} \\ \hline 250' \times 250' \times 2.9' \\ \hline 547,390 \\ \hline 0.33 \text{ acre-feet} \end{array}$$



Example 2.

$$\begin{array}{r} \text{length} \times \text{length} \times \text{average depth} \\ \hline 200' \times 100' \times 2.8' \\ \hline 547,390 \\ \hline 1.3 \text{ acre-feet} \end{array}$$

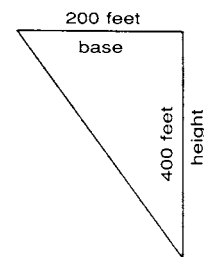

Example 3.

$$\begin{array}{r} (\text{base} \times \text{average height}) \times \text{depth} \\ \hline 200 \times 400' \times 3' \\ \hline 87,120 \\ \hline 2.8 \text{ acre-feet} \end{array}$$



# AQUATIC WEED CONTROL

---

**Aquatic plant life is desirable in aquatic habitats. One-celled aquatic plants (algae) are the basis of the food chain and supply oxygen to the aquatic system. Larger plants offer shelter and breeding habitat for many aquatic organisms. A balance between plants and other aquatic life is therefore beneficial.**

**When aquatic plants begin to flourish and affect human activities negatively, these plants are referred to as “weeds.” The “weed” determination may be based on the location in which the plants are growing such as boating lanes or around boat docks. Problems also arise when the aquatic plants interfere with the intended use of the body of water such as swimming, skiing or fishing.**

**Most problems are caused by introducing exotic species which have no natural controls to keep growth in check. Without these natural control mechanisms, the plants quickly replace native vegetation. Exotic species that have become problems are water hyacinth, alligatorweed and hydrilla.**

## **Factors Affecting Control**

Environmentally sound and cost-effective management decisions should be the basis of any aquatic weed control program. Plant identification is critical because control methods are usually species specific. All control measures will affect the environment, so it is important to consider the intended use of the water body. Physical constraints such as shallow water or obstacles can impair herbicide applications. Water quality variables such as total alkalinity or the possibility of dissolved oxygen depletions are important considerations. Potential impacts on fish and wildlife populations must also be considered.

## **Pond Construction**

Prevention is the easiest and most economical method to control aquatic weeds. Proper site selection is the first step in preventing aquatic weed problems. Sites should be selected that minimize erosion, nutrient enrichment from runoff and high water flows through the pond. Avoid using a flowing stream as a water source because the continuous flushing creates clear water and causes low contact times for herbicides and fertilizers. Maintain proper watershed-to-pond ratios. Limit livestock usage in the watershed to lessen erosion and levee destruction. Pond banks should be as steep as possible without causing excessive sloughing. Inside levee slopes should drop 1 foot for every 3 feet the slope extends into the water. Avoid areas shallower than 3 feet deep to minimize excessive weed growth. Encourage grass species along banks such as Bermuda and rye.

## **Preventive Fertilization**

Fertilization provides nutrients for algal growth, which reduces light penetration below the level required for submerged plant growth. Once fertilization has begun, you must continue the program to prevent adverse effects on fish populations. Do not start a fertilization program until the current weed infestation is controlled. The plants you are trying to control will use the nutrients and increase their growth. Liquid fertilizers are preferred because they give faster results.

## **Drawdown**

Drawdown is limited to lakes and ponds with adequate water control structures and a reliable source of water for refilling the pond. Drawdowns

are usually conducted during winter to expose plants to drying and freezing. The advantages include low cost as well as oxidation and consolidation of sediment. Drawdowns also increase options for chemical control because some chemicals are more effective when applied to dry water bottoms. One disadvantage of drawdowns is that they may reduce desirable species and allow tolerant species to spread further. There may also be some loss of recreational benefits such as duck hunting and spring fishing.

### Mechanical Control

Physical harvesting by hand or equipment can be effective at removing small populations of nuisance weeds such as duckweed, cattail and water hyacinth. This can be accomplished with various methods such as dip nets, sickles or blades, and by placing barriers across incoming streams to restrict floating plants. The main advantages to mechanical control are low cost and low environmental impact.

### Biological Control

There have been many attempts to control aquatic plants with biological control methods. These include pathogens, insects and herbivorous fish. For the average pond owner, the use of herbivorous fish like triploid grass carp is the only biological control method available. Triploid grass carp are functionally sterile, meaning they cannot reproduce in ponds. The Louisiana Department of Wildlife and Fisheries has developed a permit to allow farm pond owners to use these fish to control vegetation.

The number of grass carp that should be stocked depends on the type of weed, condition of the ponds and severity of the weed problem. Triploid grass carp prefer submerged plants, but some emergent species are also controlled. Some recommendations for stocking rates are given in the next column.

### Recommended Stocking Rates for Triploid Grass Carp

Weed Evaluation	Number of Fish to Stock per Acre
New pond or very slight weed problem	5
Moderate weed problem (10 to 20 percent coverage)	10 to 15
Severe weed problem	5 to 20 or more

### Chemical Control

About 200 herbicides are registered in the United States, but only 10 are labeled for aquatic sites. These chemicals can control aquatic weeds effectively. However, correct weed identification and matching the proper herbicide to the particular weed problem are extremely important.

Aquatic plants which are usually considered problems are divided into four groups: algae, floating, submergent and emergent weeds. Algae are small, usually microscopic plants lacking leaves, roots and stems. These plants may be made up of only one cell, an aggregate of cells called a colony or a chain of cells called a filament. Algae may grow freely suspended in the water (plankton), floating at the water surface (pond scum) or attached or unattached on the bottom.

Free-floating weeds such as duckweed and water hyacinth have leaves and stems above the surface and roots that suspend in the water below.

Submergent weeds are usually rooted at the bottom and often extend to the water surface. Common weeds in this group are pondweed, coontail and watermilfoil. Emergent vegetation is also a problem in ponds and lakes. Growth usually occurs on or near shore and in shallow water areas. Plants are rooted in the bottom, and their leaves and/or stems extend above the water surface. Common emergent weeds are smartweed,

alligatorweed and cattail.

When considering herbicides for control of aquatic weed problems, remember two important points. First, the label on the herbicide container provides specific information on the proper use of the chemical. Protect yourself and others by reading and abiding by directions and warnings on the product label.

A second consideration is that as dead aquatic plants decay, oxygen in the surrounding water is used in the process. If large quantities of plants are killed with one treatment, dissolved oxygen in the water may be reduced to the point that fish and other aquatic organisms die. Therefore, it is usually desirable to treat only a portion of a weed problem at a time. This allows the body of water to recover lost oxygen before subsequent treatments. The possibility of low oxygen becomes more serious as water temperatures rise in late summer. If possible, weed problems should be dealt with when water temperatures are between 70 and 80 degrees F.

There are several methods for applying herbicides. Some herbicides can be applied directly from the container. Handheld or backpack sprayers are used for spraying emergent vegetation around the shoreline. Boat-mounted tank sprayers can be used for either surface spray or subsurface injection. Hand-operated or mechanical spreaders are used for dispensing granular material. Granular material can also be dissolved by towing it in a bag behind a boat.

When considering chemical control, check with the parish Cooperative Extension Service office or a fisheries biologist for plant identification and current herbicide recommendations. Additional information on aquatic weed control and related topics is available from your local Extension office. Request these publications: Handbook for Common Calculations in Finfish Aquaculture, Pub. 8903; Aquatic Weed Management: Herbicides, Pub. 2398; Aquatic Weed Management: Control Methods, Pub. 2410.

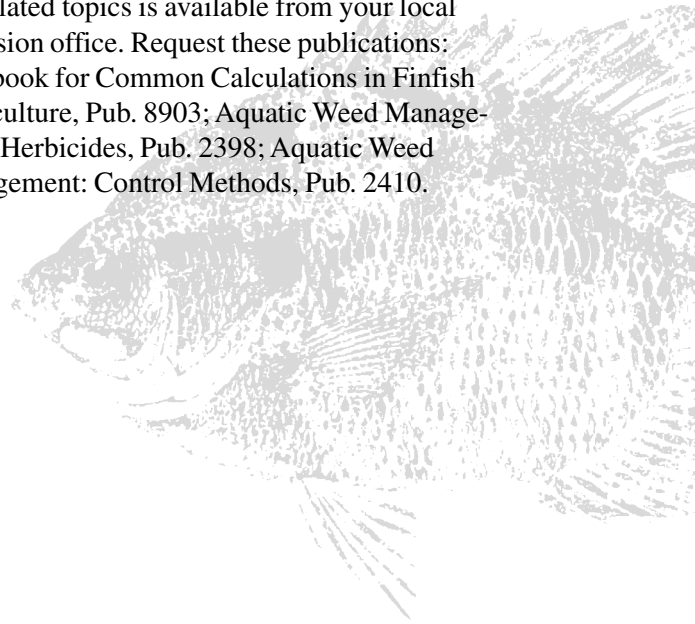
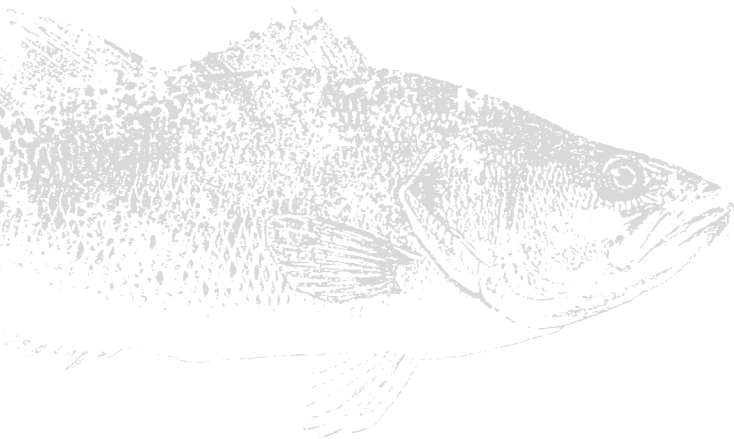

# NUISANCES AND PREDATORS

## Furbearers

Damming and burrowing activities of beavers, muskrats and nutria may cause physical damage to ponds by weakening levees and interfering with control structures. Local conservation agents can recommend legal control measures and possibly assist in trapping and relocating certain animals.

## Snakes

Although it is difficult to eliminate snakes from most ponds, they can be encouraged to leave the area by removing cover such as brush, rocks and high grass in the immediate vicinity. Snakes which remain or appear later can be destroyed as opportunities permit.

## Turtles

Although turtles rarely prey on fish directly, they can increase to the point where they become a nuisance. In this situation, they can be trapped and destroyed. A number of trap designs have been used successfully. (see Figure 24)

## Birds

A number of bird species may visit farm ponds, but few are serious predators on game fish. If a particular type of bird causes unacceptable losses, frightening techniques are generally recommended. Many birds are protected under state and federal laws, which effectively rule out shooting or poisoning.

## Mosquitoes

Excessive mosquito reproduction can usually be avoided by eliminating rooted vegetation from ponds. If this does not control the problem, it may be necessary to introduce mosquitofish, also called gambusia minnows, from ditches or other established water bodies in the area. Be careful not to introduce any fingerling trash fish when collecting and stocking mosquitofish.

Figure 24. Turtle Trap Designs

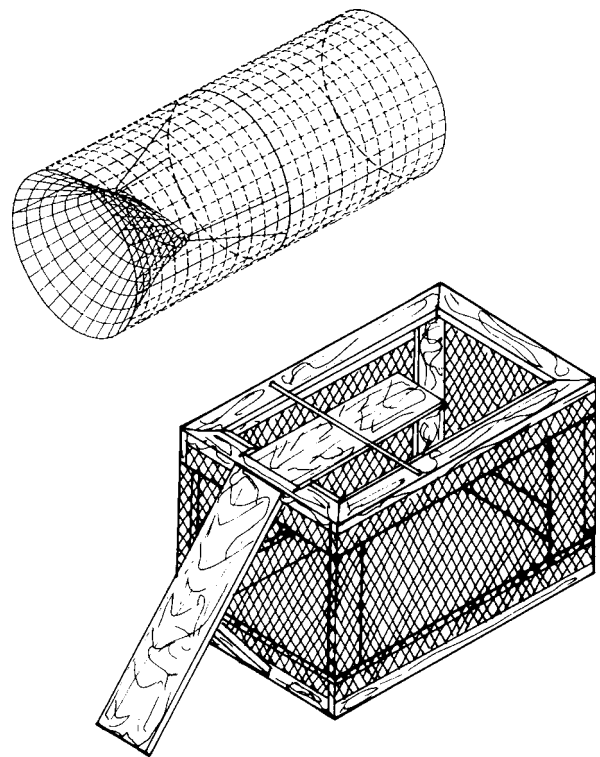

# NOTES

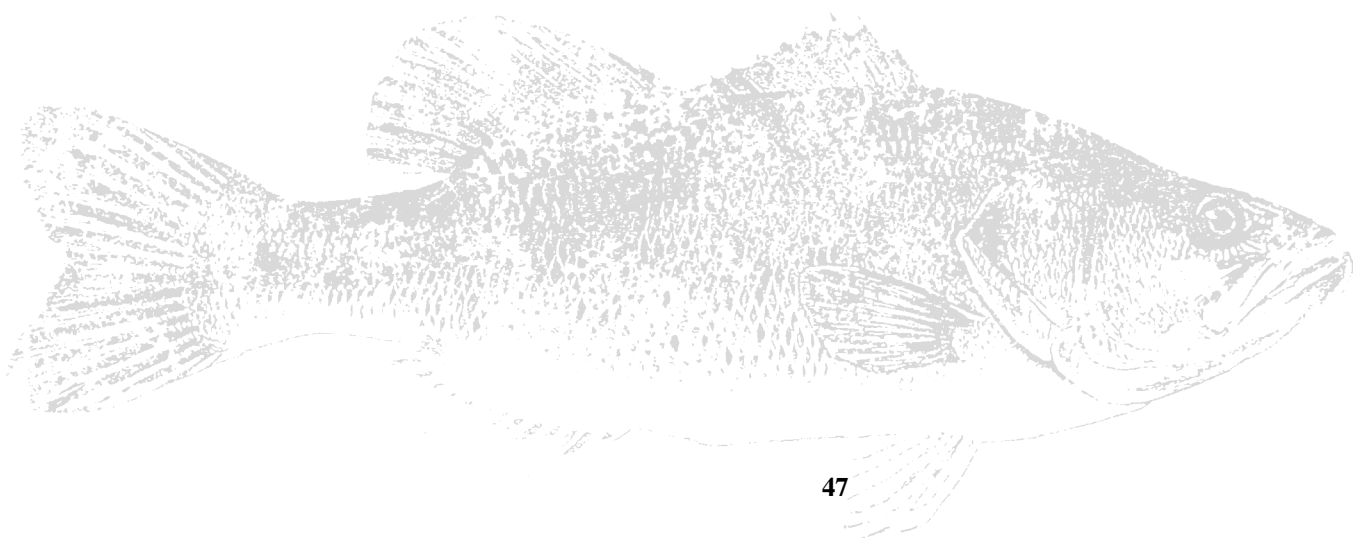

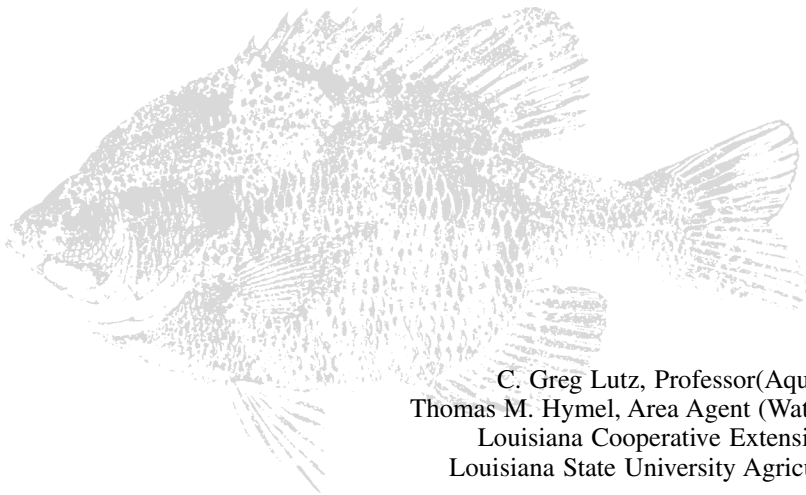

C. Greg Lutz, Professor(Aquaculture)  
Thomas M. Hymel, Area Agent (Watershed Educator)  
Louisiana Cooperative Extension Service  
Louisiana State University Agricultural Center

William E. Kelso  
LSU School of Renewable Natural Resources  
Louisiana State University Agricultural Center

Jeff Slade  
Formerly LSU Sea Grant Legal Program

Visit our Web site: [www.lsuagcenter.com](http://www.lsuagcenter.com)

**Louisiana State University Agricultural Center**  
William B. Richardson, Chancellor  
**Louisiana Agricultural Experiment Station**  
William H. Brown, Vice Chancellor and Director  
**Louisiana Cooperative Extension Service**  
Paul D. Coreil, Vice Chancellor and Director

**Pub. 2573**

**(20M)**

**11/03 Rev**

Issued in furtherance of Cooperative Extension work, Acts of Congress of May 8 and June 30, 1914, in cooperation with the United States Department of Agriculture. The Louisiana Cooperative Extension Service provides equal opportunities in programs and employment.