



# Neighborhood and Urban Pond Management

**Marley Beem**  
Assistant Extension Specialist

Attractive ponds which support fish, plants, and other aquatic life can be a major enhancement to the quality of life in neighborhoods and other urbanized settings. Unfortunately, problems with such ponds are common and solutions usually require cooperation between neighbors. A pond is not simply an earthen basin filled with water; you must also consider the watershed which fills it. Anything spilled or applied in the watershed will likely reach the pond, and may degrade the appearance of the pond or its suitability to fully support a healthy aquatic ecosystem. Pond management involves managing people. Working to educate yourself and others and to change attitudes is essential if a pond is to be improved and maintained. Many sources of assistance are cited throughout this Fact Sheet. They are marked with an “\*” to indicate that contact information is provided at the end.

## Algae

These simple plants are of two forms: planktonic (Figures 1 and 2) or filamentous (Figure 3). A moderate amount of algae is normal and beneficial, but excess growth of algae is unsightly and often leads to fish kills. When runoff from the watershed carries excess phosphorous and other nutrients from fertilized yards and lawns into the pond, algae becomes overabundant. Occasionally improperly maintained septic systems or sewers or other sources are the problem. Most species of planktonic algae produce a greenish-colored pond (Figure 1) but occasionally brown, red or yellow phytoplankton blooms occur. The box on page 2 explains how to measure the density of a phytoplankton bloom and determine if it is excessive.

Oklahoma Cooperative Extension Fact Sheets are also available on our website at: <http://osufacts.okstate.edu>

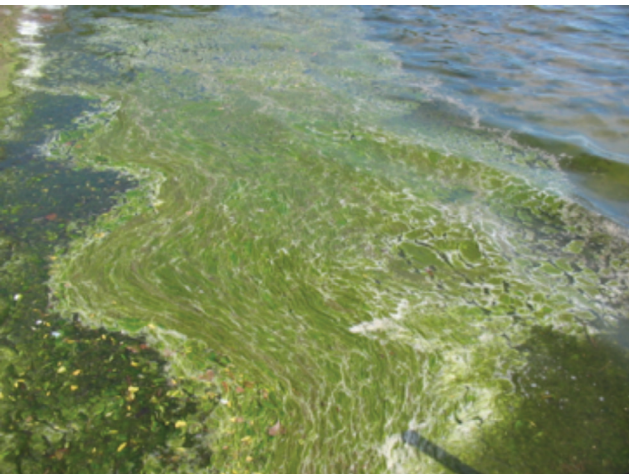

**Figure 2.** When nutrient runoff is high, planktonic algae sometimes create unpleasant surface scums like this one. (Credit: Iowa Lakeside Laboratory)

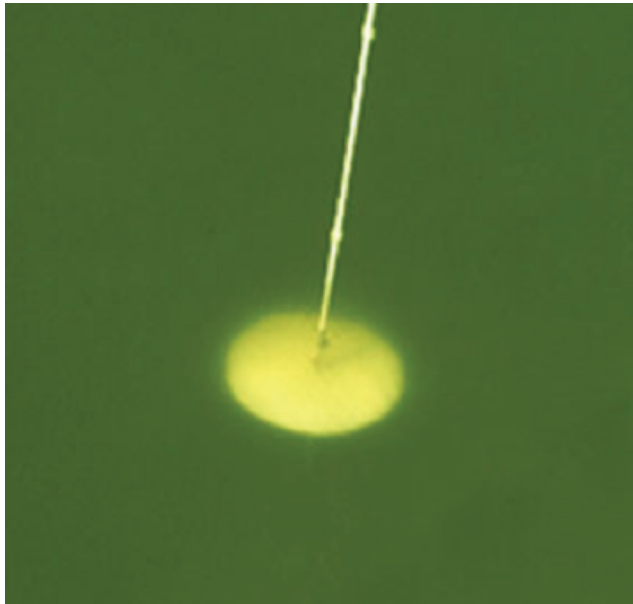

**Figure 1.** Planktonic algae are microscopic and typically give the water a greenish color. (Credit: Smithsonian Environmental Research Center)



**Figure 3.** Filamentous algae is stringy and without leaves or stems. It begins growing on the pond bottom and later forms floating mats (Credit: University of Arkansas at Pine Bluff)



**Figure 4. The percentage of phosphorous content is shown as the middle number on fertilizer labels. (Credit: University of Minnesota Extension)**

The first reaction of most pond owners with an algae problem is to use an herbicide to kill the algae. This seldom provides good long term results. Algae have an amazing ability to rapidly repopulate when nutrient and light levels are high.

The most effective method for reducing the growth of algae is to starve them of nutrients and light. To reduce nutrient runoff to the pond, soil test to determine actual lawn fertilizer needs or simply stop using fertilizers which contain phosphorous (Figure 4). Homeowners and commercial lawn care professionals should apply only the amount of phosphorous and nitrogen needed. Soil tests available from Cooperative Extension Offices\* provide the actual amount of fertilizer required to meet the needs of a lawn.

Other factors can also be responsible for pond color and turbidity. Suspended clay particles from eroding areas, such as construction sites, greatly reduce needed light penetration and degrade pond appearance (see [Common Pond Problems, NREM-9206](#)). Staining by leaves and other plant matter can lead to tea or copper-colored pond water. Such water is often acidic and may be poorly suited for fish.

## Higher Plants

Many of the same principles apply to higher aquatic plants, but water depth is also important. Medium depth areas of ponds are home to plants that are entirely or almost entirely submerged. In moderation, submerged plants are very beneficial for the pond fishery by providing insects and hiding areas for smaller fish. Twenty percent plant coverage (i.e. plants growing beneath 20 percent of the pond's surface) is considered ideal from a fishing perspective. Rooted aquatic plants also help provide balance by competing with phytoplankton and filamentous algae for nutrients and light. A leading complaint about excessive growth of submerged plants is fouling of angler's hooks.

Shallow pond areas will naturally be occupied by emergent aquatic plants. When building a pond, be cautious about including too many shallow areas – "Build it correctly and they will not come." A leading complaint about emergent aquatic plants is that tall species, like cattails and bulrushes, hide a pond from view.

Unfortunately as ponds age, shoreline areas tend to slump, resulting in shallow edges. Likewise, sediment from an eroding watershed will flow into a pond and increase the amount of shallow areas. Rebuilding pond edges is needed at intervals of 10 or more years in most ponds.

While some may object to the appearance of aquatic plants at the pond's edge, allowing less aggressive shoreline plants (Figure 5) to grow offers several advantages. They help prevent shoreline erosion and benefit fishing by providing a place for fish to find insects and refuge for smaller fish to escape largemouth bass. Habitat is also created for dragonflies, frogs and other

## Measuring Pond Turbidity with a Secchi Disk

A Secchi disk is an 8-inch diameter disk of rigid material with an eyehook in the center. Lead or other heavy material is attached to the underside to facilitate sinking. A rope is attached to the eye. They can be made or purchased.

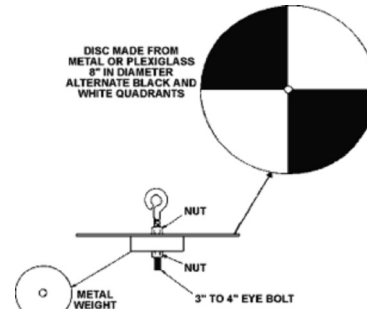

(Credit: University of Massachusetts)

Instructions for taking Secchi disk measurements vary between different sources, but here is one simple method:

**What** – Are you seeing phytoplankton? Phytoplankton blooms are usually green or blue-green in color and rarely brown, red or yellow. Or are you seeing suspended clay? Or is the pond one of the rare ones in which the water is stained by an overabundance of leaves or something similar?

**Where** – A dock is ideal. A boat also works. Without one of these it will be difficult to get a good reading. You must look straight down to see the disk in the water.

**When** – Pick a cloudless day without much wind so as to minimize glare and ripples. Take your measurement during the sunniest part of the day. Monthly measurements during the spring, summer and fall are recommended.

**How** – Look straight down as you lower the disk on the sunny side of the dock or boat. An underwater viewing device, or viewscope, is an option to eliminate surface glare and wave effects. Do not wear sunglasses. Keep lowering until you see the white glow disappear. Now slowly raise it until it first comes into view. Pinch the rope at the point where it meets the water surface. Hold the pinch point on the rope and measure the distance from there to the disk. This is the Secchi disk depth.

In general, a phytoplankton Secchi depth of between 18 and 12 inches during the warm months is acceptable. As Secchi depths approach 12 inches, the risk of a phytoplankton die-off increases. Readings of less than 12 inches indicate a much higher risk of a die-off and fish kill.

**Why** – The Secchi disk reading is a low tech but very useful measure of the turbidity of your pond. In the case of phytoplankton turbidity, a small Secchi depth measurement indicates a need to reduce nutrient runoff and take other steps to help avoid a fish kill. For more information, go to <http://dipin.kent.edu/>.





Water Iris



Waterwillow



Pickerelweed



Arrowhead

**Figure 5. Shoreline aquatic plants that are less aggressive and less prone to taking over large areas include water iris, waterwillow, pickerelweed, and arrowhead. These can still cover large areas if much of a pond is shallow.**

animals. Many children will not have the opportunity to explore nature unless a conscious decision is made to create wildlife habitats, such as naturally vegetated pond edges. It is hoped that exposing more young people to nature will reduce the number of adults with aesthetic objections to natural areas and suffering from nature phobias.

Ponds can be allowed to become populated by plants whose seeds or other propagules arrive on their own or plants can be deliberately transplanted. Take care in selecting plants to introduce into a pond so as not to introduce undesirable plants (Figure 6). It is possible to unintentionally introduce plants whose seeds or other propagules are transplanted at the same time as a desirable plant. Before moving plants from another site, first look around to see if any undesirable plants are present. If so, you may be moving their seeds or other resting stages when you dig up and transplant something. Intentional introductions of exotic plants by people can also lead to problems (Figure 7). Commercial aquatic nurseries are another source of plants. Do not use any of the prohibited plants listed by the Oklahoma Department of Wildlife Conservation (ODWC) <http://www.wildlifedepartment.com/aquaticplants.htm> or [www.ok-invasive-plant-council.org](http://www.ok-invasive-plant-council.org). "Don't Free Lily" is a publication available from the Oklahoma Department of Wildlife Conservation\*, which illustrates many of these prohibited plants.

It is possible to estimate how much of a pond will likely grow up in emergent shoreline and submerged plants. In general, rooted plants will grow in areas with 3 1/2 feet of water depth or less. Typically, smaller ponds have proportionately more shallow areas and so may appear to be overgrown by shoreline plants. Opinions vary about the amount of plant coverage that makes for a desirable pond appearance.

It is also possible to manage ponds without higher aquatic

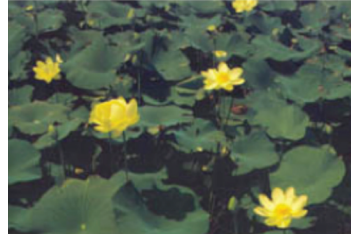

American Lotus



Cattails



Creeping Water Primrose

**Figure 6. Shoreline plants which are noted for aggressively taking over shallow areas include American lotus, often mistaken for water lilies; cattails; and creeping water primrose, which create a shoreline band around 15 feet or so in width.**



**Figure 7. A Norman, Oklahoma neighborhood pond is choked by an exotic plant, water lettuce. Beware of exotics from water gardens and other sources. (Credit: B. Hoagland)**

plants, but many of the problems discussed above will be ongoing issues. Shoreline erosion may require the construction of expensive retaining walls. Ongoing herbicide applications or other expensive plant control measures will be needed to exclude plants that want to naturally grow in a pond. The choice of how to manage pond edges is one that neighborhoods and communities should consciously make. One suggested approach is to allow just a portion of a pond's shoreline to have higher aquatic plants. Pond users will then be able to judge for themselves between the two options as they observe and consider firsthand the pros and cons in terms of erosion control, wildlife habitat and aesthetics.

## Fertilizer Runoff

Rainfall runoff in the watershed will carry any excess or improperly applied fertilizers to ponds and creeks, potentially resulting in excessive growth of algae or sometimes higher plants. The best answer to this problem is not to use herbicides to control aquatic plants but rather to reduce



(credit: UF/IFAS)

excess fertilizer application in the watershed. Soil testing saves money by determining the actual need for nutrients. Good soil test results depend on correctly collecting a soil sample:

1. Follow a random pattern when sampling. Use a soil core sampler to take about 10 to 15 cores from the established turfgrass area. A “sharpshooter” shovel can also be used to take samples.
2. All cores should be taken at a consistent depth (3 to 4 inches). Discard thatch, leaves, and stems.
3. Place all samples in a container and mix thoroughly.
4. Remove a one-pint soil sample and take it to your County Extension office for soil test analysis. Routine analysis will include N, P, and K soil levels and pH. The OSU soil laboratory or your county extension educator\* will write your fertilizer recommendations, based on your soil-test results. The basic OSU soil test remains a bargain at only \$10.

For more information on soil testing, see [Soil Testing, the Right First Step Towards Proper Care of Your Lawn and Garden, OSU Leaflet 249](#).

The key to changing the fertilizer application practices of your neighbors is polite persistent persuasion. While challenging, it can be done if enough people are committed to making it happen. You may or may not wish to link this to other neighborhood issues, such as neighborhood tree planting or crime watch

### Brookdale Neighborhood Annual Pond Report

Our pond at the corner of 5th and Elm St is open to all residents and their guests and is one of the great things about our neighborhood. To keep the pond looking good and free from excess algae and help prevent fish kills, the Cooperative Extension Service advised us five years ago to cut down on the amount of phosphorous fertilizer used on lawns and yards in the area. We are slowly but surely making progress due to your help!

You can learn the amount and type of fertilizer that is correct for your lawn by getting a soil test done by the Extension office (phone number). If you do not care to test your soil and your grass growth has been good in the past, we recommend you avoid the use of any fertilizers with a phosphorous content of more than 3%. Phosphorous percentage is the middle number on the bag. For instance, 10-20-10 has 20% phosphorus and is a fertilizer we do not recommend.

Our pond's average summer Secchi depth measurement for last year was 11.4 inches. This shows that our pond is getting clearer and improving due to more people taking care in the kinds of fertilizers they buy and the amounts they are using. But we still have further to go before the risk of fish kills is reduced to a lower level. If you have questions or would like to learn more, call Sidney and Jessie Smith (phone number) or Ariel Williams (phone number). Our goal is to reduce fertilizer applications enough to have Secchi disk readings in the 12- to 18-inch range.

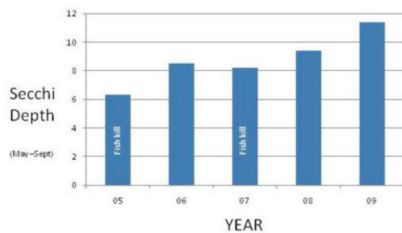

**Fertilize sparingly and carefully**

Figure 8. A sample feedback report of the type which might be used as part of a campaign to reduce fertilizer over application in a neighborhood watershed.

programs. A foundation of good communication (Figure 8) and neighborliness is needed for any cooperative effort to succeed.

Initially perhaps only a few people will be willing to cooperate and most others will be non-committal. A few will likely be opposed. Your Cooperative Extension Office\* may be able to offer a lawn care workshop in the neighborhood to help reinforce what you are saying, in the minds of your receptive neighbors. Most neighbors will not change their practices the first year. Use subsequent problems with excess algae or fish kills as opportunities to politely remind neighbors that the cause of the problem is excess fertilizer application and they can help solve the problem. To learn more about other ways to improve the quality of runoff from yards and other urban areas such as rain gardens (Figure 9), see the OSU Low Impact Development website, <http://lid.okstate.edu/>.

A neighborhood campaign to reduce fertilizer use can be made more effective if you develop and make use of a short, upbeat message or phrase. Select one “slogan” and use it every time you communicate. Examples of campaign slogans which have been used include:

- Don't “P” on Your Lawn
- Fertilize Sparingly and Caringly
- Many Things You Put on Your Yard, Wind Up in Our Pond
- When You're Fertilizing the Lawn... You're Not Just Fertilizing the Lawn
- Do Your Part, Fertilize Smart

Test the message on several people to learn if their reaction is what you are aiming to accomplish. Getting the message across will require repetition.

Once an engaging message phrase is developed, five tools can be used to help motivate people to change their lawn and yard fertilization practices:

- **Prompts** – Use small reminder signs at the pond or other strategic spots, door hangers in the spring. Make the wording simple, very brief and clear.
- **Feedback** – Let neighbors know what is working through one-on-one visits, newsletters, yearly picnic, etc.
- **Establishing New Social Norms** – Use yourself or other homeowners as models. Consider establishing demonstration yards.
- **Commitments** – Get neighbors to make verbal or written agreements to try a new practice – soil testing, zero P fertilizer etc.
- **Incentives** – Stimulate interest through contests or coupons for appropriate fertilizers, soil testing discounts or similar means.

Fact sheets and flyers, such as the one shown in Figure 10, provide a simple, engaging way in which motivated stakeholders can learn how to better manage their lawns and yards.



Figure 9. Rain gardens work to slow down and cleanse runoff water by capturing it in a low spot in the yard, where it soaks in so that soil microbial action and plant nutrient uptake can occur. (Credit: University of Wisconsin Extension)



## Fertilize sparingly and caringly

**Sweep it.** Fertilizer and grass clippings left on sidewalks and driveways wash into storm drains. So, save money – and our lakes and streams – by sweeping or blowing fertilizer and grass clippings back onto the lawn.

**Hire smart.** Select a lawn service that offers a controlled release or slow-release nitrogen, low or no phosphorus option. Request a soil test to ensure the right amount is applied.

**Don't guess, soil test.** A soil test will tell you what, if any, fertilizer is needed in your yard. Contact your Oklahoma Cooperative Extension Service county office for more information.

**Buy low.** Choose a fertilizer with low or no phosphorus. Many lawns, especially those which have been fertilized with phosphorus over several years, already contain enough phosphorus. Excess phosphorus causes algae blooms in our ponds and lakes!

**Go slow.** Select a controlled release or slow-release fertilizer. Check the label. A slow-release fertilizer is one with at least half of the nitrogen in “water insoluble” form. Slow-release fertilizers provide a steady supply of plant nutrients over an extended period of time.

**Mow high.** Make your lawn cheaper and easier to maintain by mowing high – 2 1/2 inches for Bermuda grass. Taller grass promotes root growth and reduces competition from many weeds. Let grass clippings fall back on the lawn. Clippings recycle nutrients back into the soil, so fertilizer needs can be reduced by 25 percent or more!

**Make fertilizer-free zones.** Keep fertilizer applications at least 20 feet away from the edge of ponds, lakes, streams, or storm drains.

***Remember, you're not just fertilizing your lawn***

(Adapted from: Southeast Michigan Partners for Clean Water)

**Figure 10. An example of an effective, clear handout for use in promoting good lawn care practices within a pond watershed.**

## Organic Matter on Pond Bottom

Some pond bottoms accumulate a black organic layer which gives off a sulfurous smell when disturbed. Usually this occurs in ponds that receive fertilizer runoff or leaf fall. This buildup of dead plant material can be harmful to fish and other life by releasing hydrogen sulfide. It may also be a source of phosphorus, promoting excess algae and aquatic plant growth. Ponds with such accumulations generally benefit from being drained and allowed to dry until the pond bottom cracks. Check with local stormwater management professionals for guidance on draining a pond so as not to harm the quality of water in receiving streams. The last water to be drained from a pond can be very high in organic matter which can deplete the oxygen in the receiving stream, causing a fish kill.

## Fish Kills

The most common cause of large numbers of pond fish dying suddenly is a lack of dissolved oxygen. Most often excess fertilizer runoff leads to excessive algal growth followed by an algal die-off. Dense algal blooms (Secchi disk less than 12

inches) tend to die suddenly. When this happens, the sudden massive decay of dead algal cells uses up all of the dissolved oxygen in the pond. It is also possible for low oxygen fish kills to occur when a pond “turns over,” that is when the bottom and top water layers mix. Most often turnovers occur in the late fall.

Generally, is it not feasible for pond owners to have a test for dissolved oxygen done because a specialized onsite test is usually needed. In most cases, a presumptive diagnosis is made based on typical symptoms. For more information see [Common Pond Problems, NREM- 9206](#).

## Dissolved Oxygen and Aerators

The typical pond does not need supplemental aeration. Most ponds receive adequate amounts of dissolved oxygen when sunlight penetrates the water column and algae or higher plants produce oxygen through photosynthesis.

In ponds with somewhat elevated nutrient levels, it may be beneficial to supplement this natural process with mechanical aerators. But most aerators are not well suited to correcting the effects of excessively elevated nutrient levels – it is far better to reduce the problem at the source through soil test-based application rates and taking care not to apply fertilizers before heavy rains or in a sloppy manner.

Adding an aerator to a pond can be a popular decision, but there are several potential drawbacks. The cost to purchase, maintain and operate such systems can be significant and should be fully understood before committing to install one. The smallest common surface fountain type aerator (0.25 hp) will not be large enough to provide a noticeable benefit for most ponds. Even so, it will use around \$100 yearly in electricity, even if only run 6 months per year and 12 hours per day. A one surface-acre pond might have a single 2.0 hp fountain aerator installed incurring a yearly electrical cost of around \$400 if run the same amount. A ten surface-acre pond might require up to seven 5.0 hp fountain aerators, which if run for the same amount would incur a cost of about \$5,600 per year. To find the cost of running aerators in each of these examples for 24 hours a day and 365 days a year, multiply by four. This information is intended only to give a ball park estimate of energy costs. Do not use it to size an aerator for a pond.

One size does not fit all – purchase aeration equipment from knowledgeable suppliers who ask for information about the surface area, depth and other characteristics of the pond and who can provide estimates of installation, operating and maintenance costs. If improperly installed or operated, submerged air diffuser type aeration systems may mix bottom waters with upper water layers, resulting in a low dissolved oxygen fish kill. Oftentimes surface aerators are not run continuously because of the cost of electricity. If this is the case, then they should be run at night when there is no natural production of oxygen by pond plants.

## The Pond Fishery

Poorly planned or unplanned stocking can introduce harmful fish species, which will prevent the establishment of a good quality pond fishery (Figure 11). If your pond contains any of these harmful species then elimination of all species through draining and drying of the pond is likely to be the best way to eliminate them and allow successful restocking with desirable species. Visit with an ODWC fisheries biologist\* for advice on pond fishery improvement and management.

Practices to help improve the pond fishery, such as catch limits, can usually only be encouraged and not imposed on people. Generally educational efforts similar to those discussed above for fertilizer use reduction are needed. Polite persistent persuasion is required. Improvements in the quality of fishing in neighborhood ponds are achievable. Begin by working to discourage or prevent the three main ways in which undesirable fish find their way into ponds:

- Dumping of bait buckets



**Green Sunfish.** Excessive reproduction, aggressively outcompetes more desirable species, large mouth, "worm tracks" on cheeks.



**Bullhead.** Excessive reproduction; muddies pond; small catfish, tail not deeply forked.



**Common Carp.** Muddies pond; barbels, bottom feeding mouth.



**Crappie.** Excessive reproduction followed by stunting, aggressively outcompetes bass and bluegill.

**Figure 11. Any of these problem fish species will make sustainable good fishing unlikely in a pond. Usually the best solution is to eliminate them by draining and drying the pond and then restocking with desirable species. (Credit: U.S. Fish and Wildlife Service)**

- Stocking of fish, which have been caught elsewhere, in the blind hope that they will grow and thrive. Unless recommended by a fisheries biologist, transplanted fish can unbalance the fishery. Another downside to unplanned fish stocking is the possible introduction of fish diseases and parasites.
- Ponds higher in the watershed. No, it doesn't rain fish – those are washing in from an overflowing pond above yours.

The fish species that are desirable in your pond will depend on pond size, fishing objectives and other factors. In general largemouth bass, bluegill sunfish, channel catfish and hybrid bluegill can be considered for stocking in a pond. Consult a fisheries biologist\* for advice on the best species options for a given pond situation. Patience is often needed because many ponds will require draining to eliminate existing fish and several years for catchable size fish to develop.

For advice on managing ponds for good fishing see [Improve Fishing in Your Pond, NREM-9209](#). Uncontrolled access and uncontrolled catch make it difficult to sustain good bass-bluegill fishing. "Put and take" management of channel catfish and hybrid bluegill may be more feasible, but the expense of periodic restocking must be considered. It may not be possible for many neighborhood ponds to support more than a mediocre fishery due to lack of control over catch and stocking.

Good fishing depends on having control over which fish are added to the pond and which are taken out. If you have little or no control, then sustainable, quality fishing will not be possible. However, even poor fishing opportunities can be better than nothing and are likely to be enjoyed by kids and others who have no other opportunity to fish.

## Are the Fish Safe to Eat?

Contamination of fish is difficult to completely avoid in urban environments where a variety of pesticides and other chemicals are applied or inadvertently released in the watershed. Sources include yard care pesticides and other chemicals as well as vehicles leaking motor oil, antifreeze, hydraulic fluid etc. Due to the number of possible contaminants and the cost of testing, there is no practical way to test fish to prove their wholesomeness for human consumption. If there is a single contaminant of concern in the watershed, then it might be feasible to have the fish tested for that contaminant, but when there are many unknown contaminants, testing becomes impractical. Encouraging wise use of chemicals and proper vehicle maintenance can reduce contamination concerns.

## Mosquitoes

Pond owners sometimes worry that their pond may be a source of mosquitoes, but there are much more likely places where mosquito larvae can develop. These include clogged rain gutters, old tires, birdbaths and anything else that can hold water. Pond fish typically do an excellent job of eating mosquito larvae. A long handled dipper can be used in several pond locations to see if there are any present (Figure 12). Gambusia (mosquitofish) are seldom needed or appropriate for stocking in ponds to consume mosquito larvae. Other fish usually do an adequate job of this without the disadvantage of mosquitofish competing with sport fish for food. Public health officials can provide expert advice on mosquito management.

## Safety

Ponds attract people and pose a drowning hazard. Special attention should be paid to children under the age of four, who are known to often simply get too close the edge and fall in. Swimming is prohibited in most urban ponds. Life saving equipment recommended for ponds includes a 12- to 14-foot long pole and rope with life preserver or specially designed "toss bag," which





**Figure 12. Mosquito larvae hang under the water surface layer and are eagerly eaten by most fish and other aquatic animals. Typical length is one half inch or less. (Credit: Wikipedia commons)**

can be thrown to a drowning person. Such equipment can be positioned at a clearly marked fence post (Figure 13). Use UV resistant materials or devise a way to protect from sunlight and other harm. A light wooden ladder can also be useful for rescuing people who fall through thin ice. Trespassers can pose both safety and liability issues. Visiting with an insurance agent, law enforcement officials or a lawyer may be advisable to minimize the legal aspects of such risks.

## Maintaining Earthen Dams

Earthen dams are vulnerable to erosion and failure if not monitored and maintained. Damage that appears minor to the untrained eye may, in fact, be a serious threat. Make a habit of walking and inspecting the dam faces and crown. Failure to maintain a dam can result not only in expensive damage but loss of life.

Good grass coverage is required to keep surface erosion from occurring. Grass on the dam should generally be mowed higher than for a lawn in order to ensure a healthy root system needed to hold soil in place. The auxiliary spillway, the lower area over which excess water escapes when the main pond drain capacity is exceeded, can also fail if erosion is allowed to start. The Natural Resource Conservation Service (NRCS)\* may be able to provide onsite or other expert assistance with earthen impoundment issues.

Burrowing animals, like gophers, muskrats and beaver, are a second cause of dam failure. Walking inspections of the dam are needed to detect burrows (Figure 14) and other nuisance animal signs. If advice on eliminating burrowing animals is needed, contact USDA-APHIS\*. Nuisance wildlife control operators\* can also assist in eliminating problem animals. Poorly constructed dams are at greater risk of burrowing damage than properly constructed ones (Figure 15).

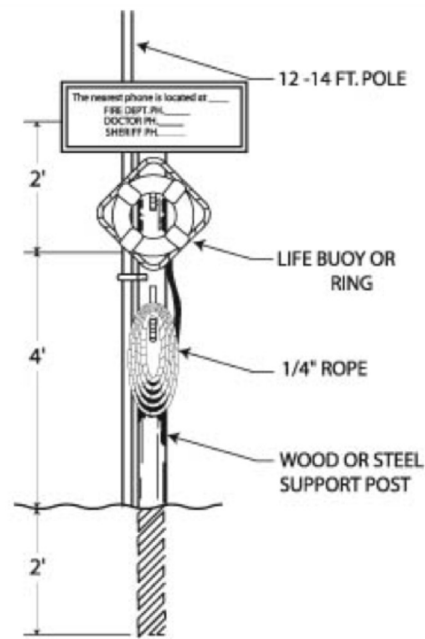

**Figure 13. A pond safety pole can save lives. (Credit: Ohio State University)**

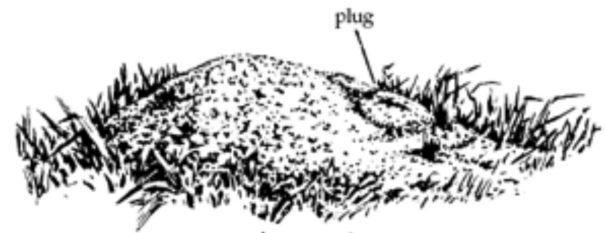

**Figure 14. Some burrows, like this gopher burrow, will be visible on the surface of a dam. Other burrowers, like muskrats and beavers will have underwater burrow entrances and other signs must be recognized in order to detect them. (Credit: Internet Center for Wildlife Damage Management)**

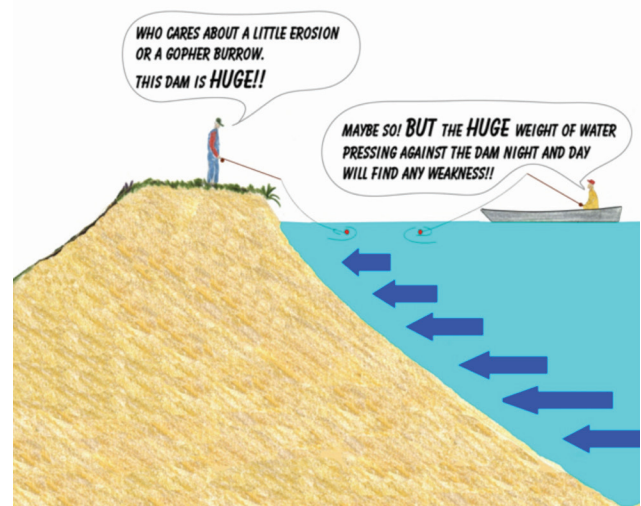

**Figure 15. Steep sided and narrow top dams are more vulnerable to damage and failure caused by animal burrowing.**

A third cause of serious damage to dams is the growth of trees and shrubs. Their deep roots loosen the compacted soil of the dam and create pathways for water to begin trickling, progressively worsening until the dam fails. Trees and shrubs should not be allowed to become established on dams. Eliminate young trees and shrubs through mowing or by use of hand tools or selective herbicides on a yearly basis.

## Shorelines

Shoreline stabilization or rebuilding is needed in many older ponds. Pond edges can become a problem over time due to wave erosion and slumping. Typically, pond edges should be built with 3:1 slopes - as you walk out three feet, there is a 1 foot drop in elevation. Three to one slopes provide three benefits: a relatively narrow band in which emergent aquatic plants can grow, a degree of safety for people wading in the pond, and a fair amount of resistance to soil slumping.

## Conclusion

Our eyes are naturally drawn to a pond. The experience can either be a pleasing one, in which we appreciate nature, or an upsetting one as we see a mismanaged eyesore. Successfully managing neighborhood and urban ponds takes effort and cooperation between everyone in the watershed. Some individuals will reflexively say that such cooperation is impossible. This is a mistaken belief. Change and involvement are possible when people have a common vision.

## Worklist

Ownership and responsibility for maintenance varies from pond to pond. The following steps are suggestions which may or may not apply to your particular situation.

### To Start:

- Identify the area that drains to the pond. Develop a watershed map to help others become aware of the area impacting the pond.
- Identify landowners, residents, yard care companies and others within the watershed that are responsible for fertilizer and pesticide use.
- Make a list of all apparent problems and concerns with the pond.

### Seek Advice and Cooperation:

- Learn the names of the aquatic plants in your pond. Help is available from your Cooperative Extension Office\* and [www.aquaplant.tamu.edu](http://www.aquaplant.tamu.edu).
- Identify fish species in the pond with the help of ODWC and discuss a fish management plan.
- Visit with NRCS\* about the dam, spillways, shorelines and other structural issues.
- Visit with city stormwater managers, engineers or similar officials, homeowner association officers or others who may have a role in improving the quality of the runoff reaching the pond. Learn who is responsible for pond upkeep and maintenance. Take the initiative and accept responsibility if there is a need to do so.
- Explore ways to reduce liability with an insurance agent, lawyer or other knowledgeable person.

### Set Your Course:

- Develop a tentative plan for pond improvement. Update as needed. Enlist other stakeholders in the effort.
- If high nutrient levels are identified as a problem, consider soil nutrient testing of your lawn and encourage others to soil test. Share results to determine if phosphorous is being over applied on most neighborhood lawns.
- Consider installing a pond safety pole (Figure 13).

### Yearly Maintenance:

- Mow dam at least twice yearly – Spring and Fall. Set mower height high to ensure a healthy grass root system to hold soil in place. If mowing is not possible, remove any young trees and shrubs using hand tools or herbicides.
- Monitor dam and spillway condition for signs of erosion and other threats discussed above. Walk the dam faces and crown and flag any suspect areas. Seek advice from NRCS\* or wildlife damage professionals\* as needed.
- Inspect shorelines for signs of erosion and slumping. Seek advice from NRCS as needed.
- Monitor changes in the area covered by aquatic plants. Identify any new plants and determine if they are invasive.
- Take monthly Secchi disc measurements (box on page 2) during the growing season to monitor phytoplankton density.
- Work to increase the neighborhood's sense of ownership of the pond as discussed above: prompts, feedback, establishing social norms, commitments, and incentives. Holiday picnics or other events held at the pond can work to increase appreciation of the pond and the steps needed to protect it.
- Check the pond bottom for a black organic layer. If present, draining and drying of the pond bottom may eventually be needed.
- Check the condition of life saving equipment at your "safety pole" and repair or replace as needed.

## Sources of Assistance

Aquatic Herbicide Applicators – a list of licensed private applicators is available from Oklahoma Department of Agriculture, Food and Forestry, 2800 N. Lincoln Blvd., Oklahoma City, OK 73105, (405)521-3864, <http://www.ok.gov/~okag/index.htm>

Oklahoma Cooperative Extension Service – County offices are listed at <http://countyext2.okstate.edu/>. - Soil testing, general aquatic plant and pond management advice.

Oklahoma Department of Wildlife – [Regional Fisheries Biologists \(http://www.wildlifedepartment.com/fishing/contactus.htm\)](http://www.wildlifedepartment.com/fishing/contactus.htm). – Fish population management, general pond and aquatic plant advice.

Pond Construction and Maintenance - Natural Resources Conservation Service – A part of the USDA with [offices in most counties \(ftp://ftp-fc.sc.egov.usda.gov/OK/intranet/OKdirectory.pdf\)](http://ftp-fc.sc.egov.usda.gov/OK/intranet/OKdirectory.pdf).

## Wildlife Damage Management

Nuisance Wildlife Control Operators – A list of licensed operators is available from Oklahoma Department of Wildlife Conservation, 1801 N. Lincoln Blvd., Oklahoma City, OK 73105, (405) 521-3851, [www.wildlifedepartment.com](http://www.wildlifedepartment.com).

USDA-APHIS, Oklahoma Wildlife Services, 2800 N. Lincoln Blvd., Oklahoma City, OK 73105, (405) 521-4039. Or toll free 1-866-4USDAWS.

Oklahoma State University, in compliance with Title VI and VII of the Civil Rights Act of 1964, Executive Order 11246 as amended, Title IX of the Education Amendments of 1972, Americans with Disabilities Act of 1990, and other federal laws and regulations, does not discriminate on the basis of race, color, national origin, gender, age, religion, disability, or status as a veteran in any of its policies, practices, or procedures. This includes but is not limited to admissions, employment, financial aid, and educational services.

Issued in furtherance of Cooperative Extension work, acts of May 8 and June 30, 1914, in cooperation with the U.S. Department of Agriculture, Robert E. Whitson, Director of Cooperative Extension Service, Oklahoma State University, Stillwater, Oklahoma. This publication is printed and issued by Oklahoma State University as authorized by the Vice President, Dean, and Director of the Division of Agricultural Sciences and Natural Resources and has been prepared and distributed at a cost of \$2.69 per copy. 0611 GH